

Twentieth Annual

CALIFORNIA DEPARTMENT OF FOOD AND AGRICULTURE  
**Fertilizer Research & Education  
Program Conference**

**PROCEEDINGS**

October 30-31, 2012 • Modesto, California



Twentieth Annual

CALIFORNIA DEPARTMENT OF FOOD AND AGRICULTURE  
**Fertilizer Research & Education  
Program Conference**

**PROCEEDINGS**

October 30-31, 2012 • Modesto, California

Editor

**L. Douglas West, Ph.D.**

Co-Editors

**Edward J. Hard**

**Erika A. Lewis**



**To order additional copies of this publication, contact:**

California Department of Food and Agriculture

Fertilizer Research and Education Program

1220 "N" Street

Sacramento, California 95814

(916) 900-5022

(916) 900-5349 FAX

[frep@cdfa.ca.gov](mailto:frep@cdfa.ca.gov)

[www.cdfa.ca.gov/is/ffldrs/frep.html](http://www.cdfa.ca.gov/is/ffldrs/frep.html)

**Publication Design:**

Erika A. Lewis

**Note:**

The summaries in this publication that are results of projects in progress have not been subjected to independent scientific review.

The California Department of Food and Agriculture makes no guarantee, expressed or implied, and assumes no legal liability for any of the information contained in this publication.



# Table of Contents

**INTRODUCTION ..... 1**

**CONFERENCE PROGRAM ..... 7**

**SUMMARIES OF PRESENTED FREP RESEARCH PROJECTS ..... 11**

<b>13</b>	Improving Pomegranate Fertigation and Nitrogen Use Efficiency with Drip Irrigation Systems <b>James E. Ayars &amp; Claude J. Phene</b>	<b>34</b>	Developing Testing Protocols to Assure the Quality of Fertilizer Materials for Organic Agriculture <b>William R. Horwath &amp; S.J. Parikh</b>
<b>18</b>	Irrigation and Nitrogen Management Web-based Software for Lettuce Production <b>Michael Cahn</b>	<b>40</b>	Assessment of Plant Fertility and Fertilizer Requirements for Agricultural Crops in California <b>William R. Horwath &amp; Daniel Geisseler</b>
<b>23</b>	Adjustable-Rate Fertigation for Site-Specific Management to Improve Fertilizer Use Efficiency <b>Michael Delwiche</b>	<b>43</b>	Towards Development of Foliar Fertilization Strategies for Pistachio to Increase Total Yield and Nut Size and Protect the Environment <b>Carol J. Lovatt &amp; Robert Beede</b>
<b>27</b>	European Pear Growth and Cropping: Optimizing Fertilizer Practices Based on Seasonal Demand and Supply with Emphasis on Nitrogen Management <b>Kitren Glozer &amp; Chuck Ingels</b>	<b>50</b>	Survey of Nitrogen Uptake and Applied Irrigation Water In Broccoli, Cauliflower and Cabbage Production in the Salinas Valley <b>Richard Smith, Michael Cahn, &amp; Timothy Hartz</b>

**SUMMARIES OF ONGOING FREP RESEARCH PROJECTS ..... 53**

<b>55</b>	Development of Leaf Sampling and Interpretation Methods for Almond and Pistachio <b>Patrick Brown</b>	<b>69</b>	Chemistry, Fertilizer and the Environment - A Comprehensive Unit <b>Judith Culbertson &amp; Mandi Bottoms</b>
<b>59</b>	Development of a Nutrient Budget Approach to Fertilizer Management in Almond <b>Patrick Brown</b>	<b>71</b>	Measuring and modeling nitrous oxide emissions from California cotton, corn, and vegetable cropping systems <b>David Goorahoo</b>
<b>64</b>	Determination of Root Distribution, Dynamics, Phenology and Physiology of Almonds to Optimize Fertigation Practices <b>Patrick Brown</b>	<b>75</b>	Remediation of Tile Drain Water Using Bioreactors <b>Timothy K. Hartz et al.</b>



- 78** Citrus Yield and Fruit Size Can Be Sustained for Trees Irrigated with 24% or 50% Less Water by Supplementing Tree Nutrition with Foliar Fertilization - Comparison of Conventional Irrigation and Partial Root Zone Drying at the Same Reduced Irrigation Rates Supplemented with Equal Foliar Fertilization  
**Carol J. Lovatt & Ben Faber**
  
- 85** Improved Methods for Nutrient Tissue Testing in Alfalfa  
**Steve Orloff & Daniel Putnam**
  
- 92** Relationship of Soil K Fixation and Other Soil Properties to Fertilizer K Rate Requirement  
**G. Stuart Pettygrove**

- 96** Nitrogen Research and Groundwater  
**Renee Pinel**
  
- 98** California Certified Crop Adviser FREP Educational Project  
**Daniel Putnam**
  
- 102** Management Tools for the Fertilization of the 'Hass' Avocado  
**Richard Rosecrance & Carol Lovatt**

**LIST OF COMPLETED FREP RESEARCH PROJECTS .....107**







# Fertilizer Research and Education Program

**FOR 20 YEARS**, the California Department of Food and Agriculture's (CDFA) Fertilizer Research and Education Program (FREP) has presented its pioneering fertilizer research at annual conferences. There are as many challenges for FREP, entering our third decade, as there were when it began. Since 2007, FREP has also collaborated with the Western Plant Health Association (WPHA) to create an alternative conference concept that balances FREP's precise, technical research with discussion on practical application. The combination has allowed FREP the means to convey its research findings in the context of topic overview and practical application and thus extend its outreach to a broader audience of agriculturalists at multiple levels.

This year, the two organizations join resources for a sixth time to offer another integrated agenda. Aptly titled, "Managing Agricultural Nutrients: Applying 20 Years of Research for the Future," this 2012 event combines the 21st Annual FREP Conference with WPHA's Central Valley Regional Nutrient Seminar. Over one and a half days, a panel of speakers will provide general and technical information, current research data, and practical applications for three key agricultural topics: nutrient management planning, implementing effective nutrient management strategies, and the basics of NPK management.

Agricultural consultants, advisors, governmental agency and university personnel benefit from the research findings, and in turn pass them on to growers. FREP's commitment to outreach and education continues; constantly seeking new ways to render research results and recommendations more useful and accessible to a broad audience of agricultural professionals. This year an online database summarizing all of the projects funded by FREP was developed and is available.

The summaries from FREP projects presented during the conference—as well as other current, ongoing FREP research—are summarized in these proceedings

## FREP OVERVIEW

The Fertilizer Research and Education Program (FREP) funds and coordinates research to advance the environmentally safe and agronomically sound use and

handling of fertilizer materials. FREP serves a wide variety of agriculturalists: growers; agricultural supply and service professionals; university extension and public agency personnel; consultants, including certified crop advisers (CCAs) and pest control advisers (PCAs); and other interested parties.

FREP was established in 1990 through legislation with support from the fertilizer industry. The California Food and Agricultural Code Section 14611(b) authorized a mill assessment on the sale of fertilizing materials to provide funding for research and education projects that facilitate improved farming practices and reduce environmental effects from the use of fertilizer. The current mill tax is \$0.0005 per dollar sales of commercial fertilizer. The assessment generates approximately \$1 million per year for fertilizer research.

The Technical Advisory Subcommittee (TASC) of the Fertilizer Inspection Advisory Board (FIAB) guides FREP activities. This subcommittee includes growers, fertilizer industry professionals, and state government and university scientists.

## FREP COMPETITIVE GRANTS PROGRAM

Each year, FREP solicits suggestions for research, demonstration, and education projects related to the use and handling of fertilizer materials. FREP strives for excellence by supporting high quality research and education endeavors that have gone through a rigorous statewide competitive process, including independent peer review. The TASC reviews, selects and recommends to the FIAB funding for FREP research and education projects. Since 2009, one or two assigned TASC members steward each research project through completion, following the progress of the project and reviewing the required reports.

Funding is generally limited to \$50,000 per year for up to three years; however, large, multi-disciplinary projects may be considered at higher funding levels.

The growing concern of nitrate contamination in ground and surface water from fertilizer use was FREP's initial research focus. In recent years, FREP's research funding has expanded to include agronomic efficiency in the management of nutrients. FREP-funded projects

continue to evaluate environmental water and soil quality.

The FREP TASC has laid out the following specific research priorities for 2012:

- Determining and updating crop nutrient uptake rates.
- Developing methodologies for minimizing fertilizer losses and maximizing fertilizer distribution uniformity.
- Developing and implementing educational activities that result in on farm changes to more efficient fertilizer use and handling of fertilizer management practices and technologies.

Additional FREP research area goals include the following:

- Crop nutrient requirements—determining or updating nutrient requirements to improve crop yield or quality in an environmentally sound manner.
- Fertilization practices—developing fertilization practices to improve crop production, fertilizer use efficiency or environmental impact.
- Fertilizer and water interactions—developing and extending information on fertigation methodologies leading to maximum distribution uniformity while minimizing fertilizer losses.
- Site-specific fertilizer technologies—demonstrating and quantifying applications for site-specific crop management technologies and best management practices related to precision agriculture.
- Diagnostic tools for improved fertility/fertilizer recommendations—developing field and laboratory tests for predicting crop nutrient response that can aid in making fertilizer recommendations.
- Nutrient/pest interactions and nutrient/growth regulator interactions—demonstrating or providing practical information to growers and production consultants on nutrient/pest interactions.
- Education and public information—creating and implementing educational activities that will result in adoption of fertilizer management, practices and technologies that improve impaired water bodies. Types of activities include:
  - On-farm demonstrations that demonstrate to growers improved profitability, reduced risk, or increased ease of management.
  - Programs to educate growers, fertilizer dealers, students, teachers, and the general public about the relationships between fertilizers, food, nutrition,

and the environment.

- Preparation of publications, slide sets, videotapes, conferences, field days, and other outreach activities.
- Additional areas that support FREP’s mission, such as air quality, tillage, crop rotation, economics of fertilizer use, and cropping systems.

FREP collaborates and coordinates with other organizations with similar goals to extend FREP research to agricultural advisors who in turn will convey findings to farmers. Our partners include: Western Plant Health Association, California Chapter of the American Society of Agronomy; California Certified Crop Adviser Program; University of California Cooperative Extension Program; University of California Sustainable Agriculture Research and Education Program; State Water Resources Control Board Interagency Coordinating Committee; California Air Resources Board; California Energy Commission; and Monterey County Water Resources Agency.

Growers have a vested interest in maintaining the viability of the resources that make farming possible and so successful here in California. We at CDFA/FREP are keenly interested in funding new projects that offer farmers alternative methods to address environmental issues and fertilizer use efficiency.

#### **Figures 1-3. FREP Project Funding**

These figures illustrate the variety of geographical regions, commodities, and disciplines covered by FREP projects during the past 20 years.

## **PROCEEDING BEYOND CONFERENCE PROCEEDINGS**

One of FREP’s key goals is to ensure that research results generated from the program are distributed to, and used by, growers and the fertilizer industry. Proceedings from past annual conferences, videos, DVDs, and pamphlets on various topics relating to fertilizing techniques are available to interested members of the agricultural community at low or no cost by contacting the FREP office.

FREP staff will be conducting an inventory of completed FREP-sponsored research to assess the utility of the research in supporting changes in grower practices. The assessment will examine whether FREP research to date has developed an adequate supply or variety of alternatives to reduce growers’ uncertainty of fertilizer management decisions regarding implementation of environmentally and economically sound use of fertilizing materials.

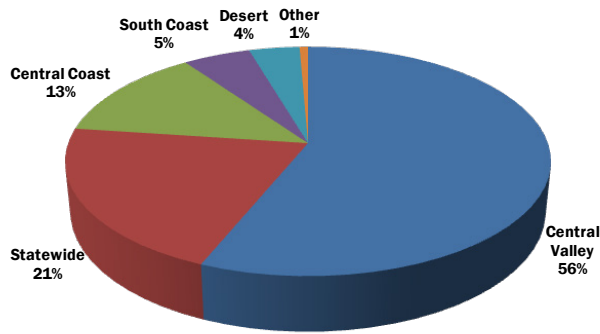

Figure 1. FREP Projects by Location, 1990-2012.

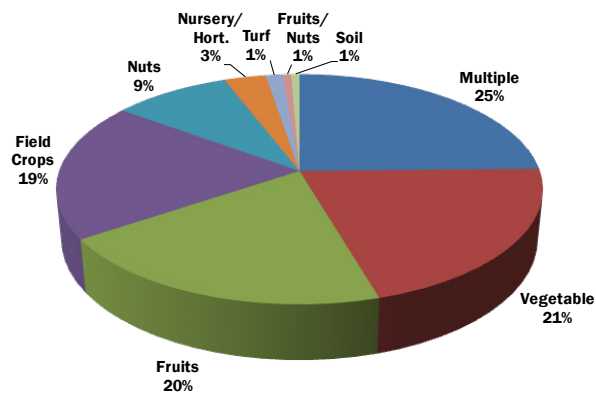

Figure 2. FREP Projects by Discipline, 1990-2012.

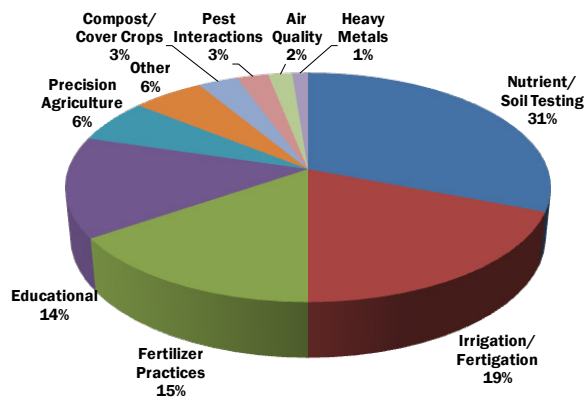

Figure 3. FREP Projects by Commodity, 1990-2012.

The study will also evaluate the applicability of research with respect to relative economic importance of the different crops grown in California, of crop-specific fertilizer demand and use by these crops, and with respect to the environmental and agronomic conditions relevant in the crops' respective growing regions. The goal of the effort is to allow FREP perspective of where research efforts have paid off with sufficient range of improved fertilizer management practices and where more research effort is needed.

We are always interested to hear how we can improve FREP services and activities. We encourage you to complete the conference evaluation form and contact us any time to offer your suggestions.

## ACKNOWLEDGMENTS

We are grateful to members of the fertilizer industry for their support in providing funds for the Fertilizer Research and Education Program. Their foresight in creating FREP and their long-term commitment and dedication have been instrumental in the program's success.

We recognize the members of the Fertilizer Inspection Advisory Board's Technical Advisory Subcommittee who review and recommend projects for funding. The professionalism, expertise, and experience of Jack Wackerman (chairman), Dr. Michael Cahn, Dr. Eric Ellison, Bob Fry, Tom Gerecke, David McEuen, Dr. Rob Mikkelsen, Dr. Jerome Pier, Chris Simas, Dr. Holly Little and Dr. Doug West have provided FREP with direction to ensure the program achieves its goals.

We thank the Western Plant Health Association as a valued partner in the "Managing Agricultural Nutrients: Applying 20 Years of Research for the Future" conference. Renee Pinel and Mary Junqueiro's perspectives, input and support have led to greater outreach and dissemination of FREP research findings.

Vital contributors are the project leaders and cooperators themselves, as well as numerous professionals who peer-review project proposals, significantly enhancing the quality of FREP's work.

Special recognition also goes to the leadership at the California Department of Food and Agriculture, including Asif Maan, Feed, Fertilizer, and Livestock Drugs Regulatory Services Branch Chief; Erika Lewis, Operations Manager for FREP; Edward J. Hard, Policy Specialist for FREP; and Doug West, Scientific Specialist for FREP.









## Tuesday, October 30, 2012

- Facilitator:** *Keith Backman, Dellavalle Laboratory, Inc.*
- 9:00-9:10**     **Welcome**  
*Renee Pinel, Executive Director, WPHA*
- 9:10-9:30     *Karen Ross, Secretary, CDFA*
- 9:30-9:50     Accessing FREP Crop Nutrient Information  
*Dr. Daniel Geisseler, UC Davis Land, Air and Water Resources*
- 9:50-10:20    4 R's of Plant Nutrient Management  
*Dr. Robert Mikkelsen, International Plant Nutrition Institute*
- 10:20-10:50   Plant Tissue Sampling through Different Growth Stages  
*Mike Buttress, A & L Western Agricultural Laboratories*
- 10:50-11:00**   **Break**
- 11:00-11:30    Optimizing Fertilizer Practices to Manage Nitrogen  
*Dr. Kitren Glozer, UC Davis Plant Sciences Department*
- 11:30-12:00    Standards for Foliar Fertilizer Effectiveness  
*Dr. Carol Lovatt, UC Riverside Botany and Plant Sciences*
- 12:00-1:00**     **Lunch (provided)**
- 1:00-1:30     Fertilization and Nitrogen Use Efficiency with Drip Irrigation  
*Dr. Claude Phene, SDI, Inc.*
- 1:30-2:20     Panel Discussion: Managing Agricultural Nitrogen in the Central Valley  
*Facilitator: Dr. Doug Parker, UC Davis, ANR*  
*Dr. Michael Johnson, East San Joaquin Water Quality Coalition*  
*Dr. Patrick Brown, UC Davis Department of Plant Sciences*  
*Joe Karkoski, Regional Water Board*  
*Gene Miyao, UCCE, Yolo County*
- 2:20-2:50     Review the Uses of Controlled Release Fertilizers, and Anticipated Benefits  
*Dr. Eric Ellison, Agrium Inc.*
- 2:50-3:00**     **Break**
- 3:00-3:30     Zinc Foliar Uptake Efficiency  
*Dr. R. Scott Johnson, UC Kearney Agricultural Center*
- 3:30-4:00     Orchard & Nutrient Irrigation Complications  
*Keith Backman, Dellavalle Laboratory, Inc.*
- 4:00-4:30     How Do We Move Forward?  
*Dr. Amrith Gunasekara, CDFA*
- 4:30-4:40**     **Concluding Remarks**



## Wednesday, October 31, 2012

**Facilitator:** *Keith Backman, Dellavalle Laboratory, Inc.*

**8:00-8:15**      **Welcome and Recap**

*Keith Backman, Dellavalle Laboratory, Inc.*

8:15-8:45      Ensuring Authenticity of Fertilizers for Organic Agriculture  
*Dr. Will Horwath, UC Davis Land, Air and Water Resources*

8:45-9:15      Irrigation and Nitrogen Management Web-Based Software  
*Dr. Michael Cahn, University Cooperative Extension, Farm Advisor, Monterey County*

9:15-9:45      Site Specific Management to Improve Fertilizer Use Efficiency  
*Dr. Michael Delwiche, UC Davis Biological and Ag Engineering*

**9:45-10:00**      **Break**

10:00-10:30      Control Release Fertilizer and Nitrification Inhibitors  
*Richard Smith, UCCE Monterey County*

10:30-11:20      Panel Discussion: Managing Agricultural Nitrogen on the Central Coast  
*Facilitator: Dr. Amrith Gunasekara, CDFA*  
*Dr. Marc Los Huertos, CSU Monterey Bay*  
*Lisa McCann, Regional Water Board*  
*Kay Mercer, KMI, Inc.*

**11:20-11:35**      **Concluding Remarks**





cover page





# Improving Pomegranate Fertigation and Nitrogen Use Efficiency with Drip Irrigation Systems

## PROJECT LEADER

**James E. Ayars**  
USDA-ARS, SJVASC  
9611 S. Riverbend Ave  
Parlier, CA 93648  
(559) 596-2875  
James.ayars@ars.usda.gov

## COOPERATOR

**Dong Wang**  
USDA-ARS, SJVASC  
9611 S. Riverbend Ave.  
Parlier, CA 93648  
(559) 596-2850  
Wangd@ARS.USDA.GOV

## COOPERATOR

**Kevin R. Day**  
UC Cooperative Extension  
4437 S. Laspina St., Ste B  
Tulare, CA, 93274, Direct  
(559) 684-3311  
krday@ucdavis.edu

## SUPPORTING STAFF

**Rick Schoneman**  
Agricultural Engineer  
USDA-ARS  
Coordinated installation and maintenance of the irrigation system and student support.

## PROJECT LEADER

**Claude J. Phene**  
SDI+  
P.O. Box 314  
Clovis, CA 93613-0314  
(559) 824-6026  
claudejphene@gmail.com

## COOPERATOR

**Gary S. Bañuelos**  
USDA-ARS, SJVASC  
9611 S. Riverbend Ave.  
Parlier, CA 93648  
(559) 596-2880  
gary.banuelos@ARS.USDA.GOV

## COOPERATOR

**Rebecca Tirado-Corbala**  
USDA-ARS, SJVASC  
9611 S. Riverbend Ave.  
Parlier, CA 93648  
(559) 596-2869,  
Rebecca.Tirado-Corbala@ARS.  
USDA.GOV

## SUPPORTING STAFF

**Rebecca C. Phene**  
Staff Research Associate II  
UC Davis  
Coordinated UC orchard maintenance, developed computer software for the lysimeter and the irrigation control systems, developed the lysimeter KARE website and measured various crop variables.

## COOPERATOR

**R. Scott Johnson**  
UC KARE Center  
9249 S. Riverbend  
Parlier, CA 93648  
(559) 646-6500  
sjohnson@ucanr.edu

## COOPERATOR

**Suduan Gao**  
USDA-ARS, SJVASC  
9611 S. Riverbend Ave.  
Parlier, CA 93648  
(559) 596-2870  
Suduan.Gao@ARS.USDA.GOV

## INTRODUCTION

Research and demonstration have shown that well managed surface drip (DI) and subsurface drip irrigation (SDI) systems can eliminate runoff, deep drainage, minimize surface soil and plant evaporation and reduce transpiration of drought tolerant crops. Reduction of runoff and deep drainage can also significantly reduce soluble fertilizer losses and improve groundwater quality. The success of DI and SDI methods depends on the knowledge and management of fertigation, especially for deep SDI. Reductions in wetted root volume, particularly if combined with deficit irrigation practices, restricts available nutrients and impose nutrient-based limits on growth or yield. This is particularly important with immobile nutrient such as P. Avoiding nutrient deficiency or excess is critical to maintaining high water and fertilizer use efficiencies (WUE & FUE). This interaction has been demonstrated for field and vegetable crops but no similar research has been conducted for permanent crops.

Pomegranate acreage in California is now about 30,000 ac and Kevin Day noted that “from 2006 to 2009 the

number of acres planted with pomegranate trees has increased from approximately 12,000 to 15,000 acres in 2006 to 29,000 acres in 2009” (Personal communication K. Day 2009). The rising demand for juices, e.g. pomegranate, blueberry, with healthy bioactive compounds, mineral nutrients and high antioxidant contents are partially contributing to this growth in acreage. Pomegranate is both a drought tolerant crop that can be grown on slightly saline soils and is thus ideally suited for the Westside of the San Joaquin Valley as a replacement for lower value crops. There have been no studies that evaluated the nitrogen fertilization requirements of a developing pomegranate orchard using either surface drip or subsurface drip irrigation. This project will initially determine the nitrogen fertilizer requirements and efficiency for a developing pomegranate orchard.

## OBJECTIVES

The overall objective of this project is to optimize water-nitrogen interactions to improve FUE of drip irrigated young and maturing pomegranate and to minimize nitrogen leaching losses.

Specific objectives are:

1. Determine the real time seasonal nitrogen requirements (N) of DI- and SDI-irrigated maturing pomegranate that improve FUE without yield reduction.
2. Determine the effectiveness of three nitrogen injection rates with DI and SDI on maintaining adequate N levels in maturing pomegranates.
3. Determine the effect of real time seasonal nitrogen injections (N) with DI- and SDI irrigated maturing pomegranate on N leaching losses.
4. Develop fertigation management tools that will allow the growers to achieve Objective 1 and present these results to interested parties at yearly held field days and seminars.
5. Determine if concentrations of macronutrients (P, K, Ca, Mg) and micronutrients (Zn, Cu, Mn, Fe, B, Se) and eventually healthy bioactive compounds in soil, peel and fruit are influenced by precise irrigation/ fertigation management with DI and SDI.

## DESCRIPTION

This project is using a 3.54-ac Pomegranate orchard (*Punica granatum*, L var. Wonderful) located on the Kearney Agricultural Center that includes a large weighing lysimeter. This lysimeter is used to determine the water balance and to automatically manage the hourly irrigation scheduling on the site and determine the crop water use for the 100% SDI-N2 treatment. Water applied to the DI treatments is increased by 20% to account for evaporation from the soil surface.

The lysimeter tree is irrigated using a SDI system with the same number of emitters per tree as the rest of the

orchard. Trees were planted with rows spaced 16 ft apart and trees in the rows spaced 12 ft along the row. There are 2 border rows with trees spaced 12 ft apart. The orchard is laid out in a complete randomized block with sub-treatments. The main irrigation treatments are DI and SDI (20-22-in depth) systems with dual drip irrigation laterals, each 3.5 ft from the trees. The fertility sub treatments are 3 N treatments (50% of adequate N, adequate N, based on biweekly tissue analysis and 150% of adequate N, all applied by variable injection of N-pHURIC (10% N as urea, 18% S), AN-20 (10% NH<sub>4</sub>-N and 10% NO<sub>3</sub>-N). Potassium thiosulfate (K<sub>2</sub>T, 25% K from K<sub>2</sub>O and 17% S) and phosphorus (from H<sub>3</sub>PO<sub>4</sub>, PO<sub>4</sub>-P) are supplied by variable injection of P=15-20 ppm and K=50 ppm to maintain adequate uptake levels. The pH of the irrigation water is automatically maintained at 6.5+/-0.5. Tree and fruit responses will be determined by canopy measurements, pruned plant biomass, bimonthly plant tissue analyses and fruit yield and quality. When appropriate, flowers, fruit yields and quality will be measured and statistically analyzed. Analysis of variance (ANOVA) for the Randomized Complete Block Design (RBCD) with sub-samples will be used to determine the treatment significance.

## RESULTS AND DISCUSSION

### 1. Pomegranate Evapotranspiration, Crop Coefficient and Lysimeter Management

Figure 1 shows data from 3/15 to 8/19/2012. Reference evapotranspiration (ET<sub>0</sub> from CIMIS) was 34.9 in, ET<sub>c</sub> (Lysimeter) was 26.3 in, Orchard ET<sub>c</sub> was 11.8 in precipitation was 5.0 in, drainage was 0. The 7-day average crop coefficient ranged from 0.19 to a high of 0.52, and irrigation water was 11.4 in and 11.9 in for the SDI and DI treatments, respectively.

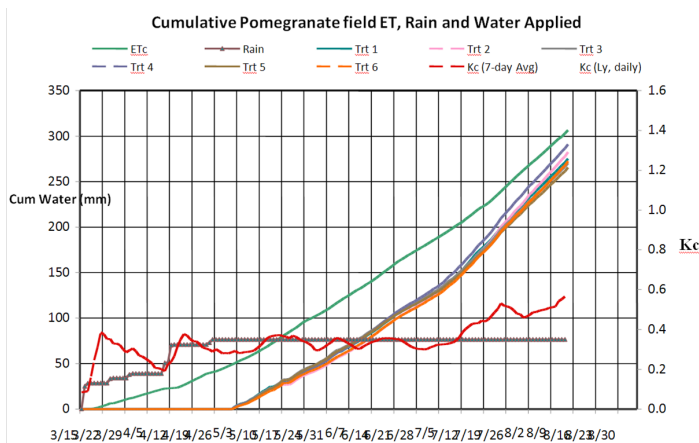

Figure 1. Pomegranate Evapotranspiration, Crop Coefficient, irrigation and Lysimeter measurements.

## 2. High Frequency Irrigation/Fertilization Management

Nitrogen was injected in the N-1 (38 lb/ac), N-2 (140 lb/ac) and N-3 (241 lb/ac) as N-pHURIC, and AN-20 from 5/10 to 8/9/12.

Phosphorus ( $H_3PO_4$ ) was equally injected in all treatments at a rate of 28 lb/ac from 5/24 to 8/9/12.

Potassium ( $K_2T$ , 25% K from  $K_2O$  and 17.5% S) was equally injected in all treatments at a rate of 43 lb/ac from 6/7 to 8/9/12.

## 3A. Soil and Plant Tissue Responses to High Frequency DI and SDI Nitrogen Injections.

In April 2012, prior to 2012 fertigation, mean soil nitrate-nitrogen measurements varied from 20.1 ppm at the 6-in depth to 5.5 ppm at 48-in depth in the DI treatments and from 10.3 to 5.2 ppm for similar depths in the SDI treatments. This is following 2011 injection of 58 lb/ac of AN-20 (as ammonium Nitrate); these data are shown graphically in **Figure 2**. Similar soil samplings were done in August and will be done again in November 2012.

Data in **Figure 3** show that leaf tissue total nitrogen ranged from 2.52 % on 5/1/2012 to a low of 1.33% on 6/15 and a slight increase to 1.44 % on 7/16 in response to N-fertigation.

## 3B. Leaf Color Measurements with the Chlorophyll Meter

On July 17, 2012, leaf color measurements were obtained using a SPAD 502 Chlorophyll Meter. Research has shown a strong correlation between SPAD measurements and leaf N content. Mean SPAD measurements in nitrogen treatments N1, N2 and N3 were 57.395<sup>a</sup>, 62.177<sup>b</sup> and 62.746<sup>b</sup>, respectively (Means with a different letter superscript are significantly different at  $p = 0.05$  according to the Tukey's studentized range (HSD) test). Leaf tissue mean total N obtained on 7/16 were 1.31, 1.44 and 1.45%, respectively for the N1, N2 and N3, corresponding well to the SPAD measurements.

## 4A. Pomegranate Canopy Cover with Multispectral Camera Measurement

On June 13 and July 17 2012, tree canopy cover in each treatment plot was measured with a TetraCam ADC multispectral camera (TetraCam Inc., Chatsworth, CA). The camera contains a single precision 3.2 megapixel image sensor optimized for capturing green, red, and near-infrared wavebands of reflected light. A TeleScoping Pole Tripod system (GeoData Systems Management Inc., Berea, OH) was used to suspend the camera directly above the trees and aim vertically downward at nadir view. The tripod system was attached to a Gator (**Figure 4**). A cross

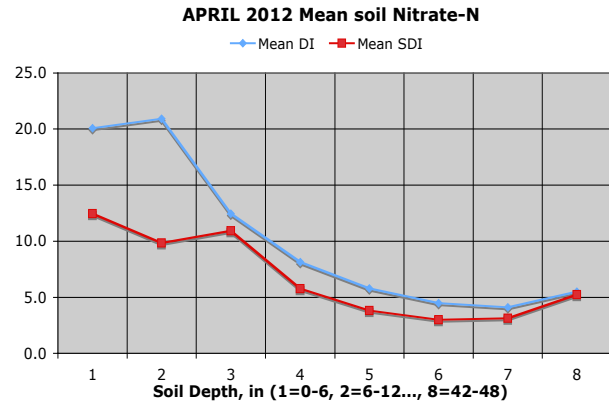

**Figure 2.** Mean soil nitrate-nitrogen responses to high frequency DI and SDI prior to fertigation.

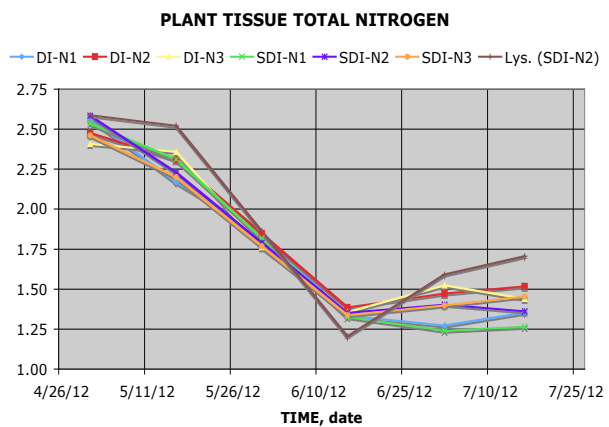

**Figure 3.** Tissue nitrogen responses to high frequency DI and SDI injected 3 levels of N.



**Figure 4.** Pomegranate Canopy Cover measurements with a Multi-spectral Camera



bar mounted with the camera was attached and locked to the tip of the pole. The pole was extended and raised to a vertical position. Sufficient counterweight was applied on the bottom of the pole to keep it vertical. The camera was suspended 18 ft above the ground surface. An image was taken above the middle pomegranate tree of the center row in each treatment plot. Canopy cover was measured with a multispectral camera on June 13 and July 17, 2012. The results from the two days show that 10% and 14% increase in the SDI treatment canopy cover over that of the DI treatment.

#### 4B. Pomegranate Canopy Light Interception with Light Bar

Figure 5 shows the light interception as affected by the irrigation and fertigation treatments. These data indicate that the canopy light interception is more affected by the two irrigation treatments than by the three nitrogen sub-treatments.

Figure 6 shows that the plant canopy light interception in the SDI-irrigated treatments increased by 66% from 12.5% in August 18, 2011 to 20.7% on July 15, 2012 and by 99% in the DI-irrigated treatments from 9.5% to 18.9%. Overall, the light interception of the SDI treatment was 9.5% greater than that of the DI treatment. In 2012 light interception will be measured every two weeks throughout the rest of the growing season and will be related to ETC from the lysimeter to help generate canopy-related crop coefficients (Kc).

#### 5. Nitrous Oxide Emission Measurements in Pomegranate Orchard

Greenhouse gas nitrous oxide N<sub>2</sub>O emissions from the pomegranate orchard at the UC KARE Center were measured using the static chamber method (Figure 7). Upon the chamber placement, N<sub>2</sub>O concentration (ppm, µg/m<sup>3</sup>) increased inside the chamber. Air samples were collected at time intervals of 0.5 or 1.0 h depending on the linearity in concentration increase. Emission flux (f, µg m<sup>-3</sup> h<sup>-1</sup>) was calculated from the linear model:

$$f = \left(\frac{V}{A}\right) \frac{dC}{dt}$$

Where dC/dt is the slope of the linear fitting by plotting N<sub>2</sub>O concentration (ppm) vs. time (h), V is the chamber volume (m<sup>3</sup>), and A is the surface area (m<sup>2</sup>).

Figure 7 shows N<sub>2</sub>O emission rates from May 1 through June 12. These data show that N<sub>2</sub>O emission significantly increases with the increase of N application rate in the surface drip irrigation. However, N<sub>2</sub>O emissions from the subsurface drip irrigation were significantly lower regardless of N application rate.

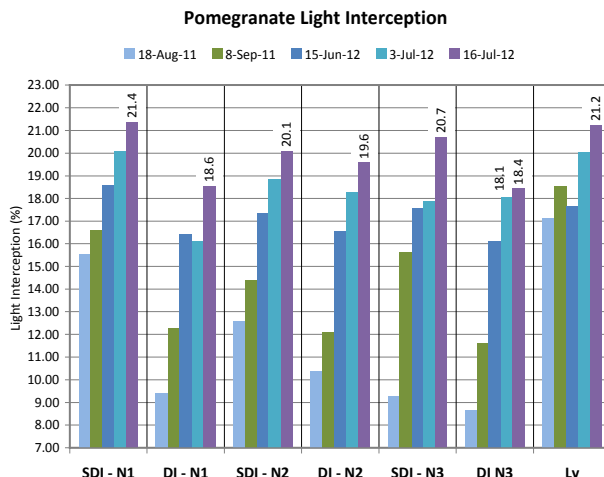

Figure 5. Light interception as affected by the irrigation and fertigation treatments.

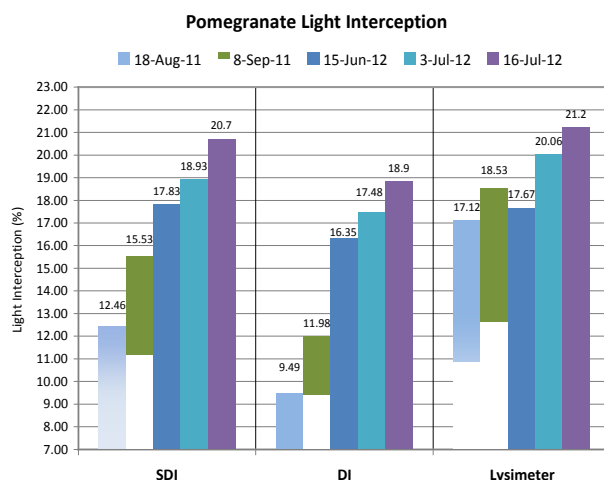

Figure 6. Light interception as affected by DI and SDI irrigation treatments.

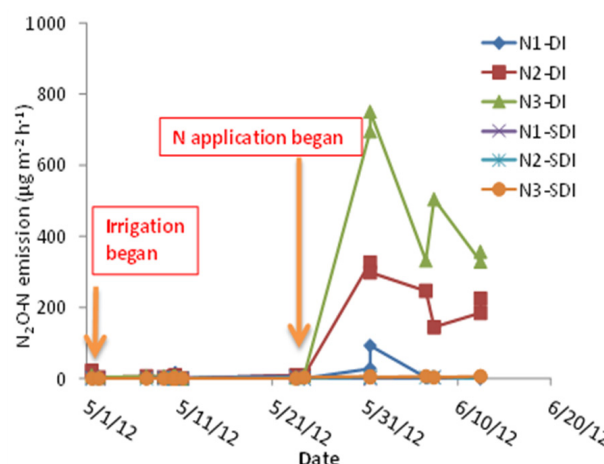

Figure 7. N<sub>2</sub>O emission rates from May 1 through June 12, 2012.

### 6. Effects of Poor Quality Water on Nutritional Content in Pomegranates

The potential effects on different nutritional parameters in 2-year old pomegranate trees were evaluated with typical water qualities present in the Westside of the California Central Valley. Irrigation waters consisted of salinity ranging from 1 to 6 dS/m, and having boron and selenium (Se) concentrations of 4 mg/L and 0.25 mg/L, respectively. Trees were irrigated individually with respective water treatment under micro-plot field conditions in Parlier, CA based in part by weather data collected from CIMIS. Results showed that vitamin C levels (Figure 8) and most total phenolic levels increased in the fruit with irrigation water containing selenium, boron, or salinity. Macronutrient concentrations, e.g., Ca, Mg, K, P, S, and Se also increased in the fruit when poor quality waters were used. These preliminary results indicate that waters of poor quality may actually improve the nutritional content of young pomegranate fruit. This observation may be useful for growers of pomegranates on the Westside of central California.

### 7. Website

In 2012, the project’s website was completed and is accessible at: [www.ucanr.org/sites/KACLysimeter/](http://www.ucanr.org/sites/KACLysimeter/)

Annual reports and quarterly updates are available to interested parties.

### PRELIMINARY FINDINGS

Preliminary results have demonstrated that the high frequency SDI System has the potential to provide:

- More efficient WUE than DI
- More efficient NUE than DI
- Larger tree than DI
- Fewer weeds than DI
- Lower potential for NO<sub>3</sub>-N leaching
- No N<sub>2</sub>O gaseous emission compared to DI
- Improved orchard access for maintenance equipment

Preliminary findings were presented at a UCCE Pomegranate Field Day on 8/21 to approximately 70 growers, UCCE advisors and irrigation industry representatives.

### ACKNOWLEDGEMENTS

CDFR/FREP Fertilizer Research and Education Program – partial funding (3 years)

Paramount Farming – trees

Lakos – Media filter set

Toro Micro Irrig – Rootguard drip tubing

Verdegaal Brothers--Fertilizers

Dorot – Solenoid & Manual valves

SDI+-- Consulting Time & equipment

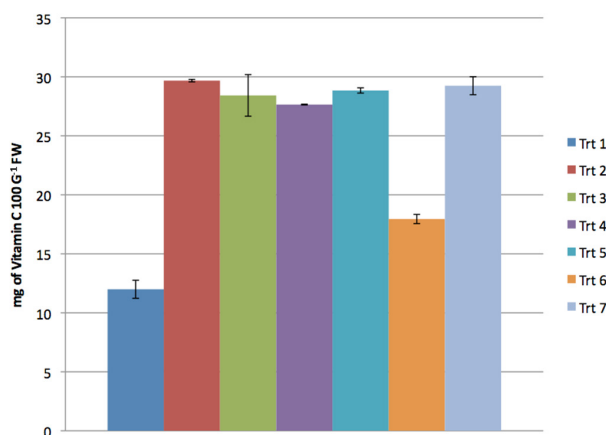

Figure 8. Effects of water quality on Vitamin C level of pomegranate.

Treatments	
1	Control
2	< 1 dS/m + 0.250 ppm Selenate
3	< 1 dS/m + 0.250 ppm Selenate + 4 ppm B
4	3 dS/m + 0.250 ppm Selenate
5	3 dS/m + 0.250 ppm Selenate + 4 ppm B
6	6 dS/m + 0.250 ppm Selenate
7	6 dS/m + 0.250 ppm Selenate + 4 ppm B

# Irrigation and Nitrogen Management Web-based Software for Lettuce Production

## PROJECT LEADER

**Michael Cahn**  
Water Resources and Irrigation  
Advisor  
UC Cooperative Extension  
1432 Abbott St  
Salinas, CA 93901  
(831) 759-7377  
mdcahn@ucdavis.edu

## COOPERATOR

**Tim Hartz**  
Vegetable Crop Specialist  
Plant Science Dept.  
University of California  
Davis, CA 95616  
Office 831-752-1738  
tkhartz@ucdavis.edu

## INTRODUCTION

Commercial lettuce production requires significant inputs of water and nitrogen (N) fertilizer to maximize yield and quality. Changes in water quality regulations on the Central Coast and higher fertilizer prices in recent years have prompted grower interest in increasing efficiency of nitrogen fertilizer use in lettuce. By improving water management and matching nitrogen applications to the uptake pattern of the crop, growers could potentially reduce fertilizer use and address water quality concerns. Two tools available to growers, the quick nitrate test and evapotranspiration (ET) data from the California Irrigation Management Information System (CIMIS), have been shown to help lettuce producers better manage water and fertilizer nitrogen. However, adoption of these practices has not been wide spread. One reason is that these techniques can be time consuming to use, and many farm managers have several hundred fields for which they need to make irrigation, fertilization, and pest control decisions during a single season.

The overall goal of this project is to develop a web-based software tool that will aid growers in optimizing water and nitrogen fertilizer applications in lettuce. The software employs established guidelines to recommend the amount of fertilizer and water to apply during upcoming irrigation and fertilizer applications. The software also helps growers track irrigation schedules and nitrogen fertilizer applications on multiple fields and allow users from the same farming operations to share data. Use of this tool may help growers reduce production costs by applying less fertilizer and water,

and minimize water quality impacts of vegetable production on surface and ground water supplies.

## OBJECTIVE

The principal goal of this project is to develop a web-based software tool that will aid growers in optimizing water and nitrogen fertilizer applications in lettuce, thereby saving production costs and minimizing water quality impacts. Specific objectives of the project are to:

1. Develop irrigation and nitrogen management software.
2. Evaluate irrigation and nitrogen management software in commercial lettuce fields.
3. Conduct educational trainings and develop a user guide for the software.

## DESCRIPTION

The goal for the first year of the project was to develop a preliminary version of the web-based software. This included developing database tables that store information about fields and ranches, algorithms used in the decision support for irrigation and fertilization recommendations, automated downloading of CIMIS reference ET data, user interface design, and finally testing the software. The second year of the project has been dedicated to updating and testing the newest version of the software using a core group growers and conducting evaluations and trials in commercial lettuce fields. The final year of the project will emphasize educational training on using the software.

## ACCOMPLISHMENTS

### Software Development Overview

In collaboration with UC Agriculture and Natural Resources, Communication Services, we launched a preliminary version of the irrigation and nitrogen management software for lettuce ([ucanr.org/cropmanage](http://ucanr.org/cropmanage)) on Sept 1, 2011. The web-based software is viewable on personal computer, computer tablet, and smart phone screens. The user is required to login before viewing their personal list of ranches/farms. By selecting a ranch, the user can view all fields currently planted. A database holds information on ranches, such as total farmable acres, well names and associated water quality, nearest CIMIS weather stations, and information about individual fields, such as acres, soil type and soil physical properties. The user can upload ranch and

field information using an Excel spreadsheet. Once the database information is entered for a ranch, the user can add new plantings to a field, which requires inputting information on lettuce type, first irrigation and harvest dates, planted acres, bed spacing, and irrigation system characteristics. The planting “home” screen displays summaries of soil tests, fertilizer applications (**Figure 1**), and watering schedules (**Figure 2**). As user enters intended dates to fertilize and/or irrigate, the summary tables are updated with recommended water volumes and fertilizer N rates.

Multiple users can view and edit data for a planting, which can facilitate sharing of information within the same farming operation. The ranch owner has the authority to assign users access to view and/or edit plantings within a ranch.

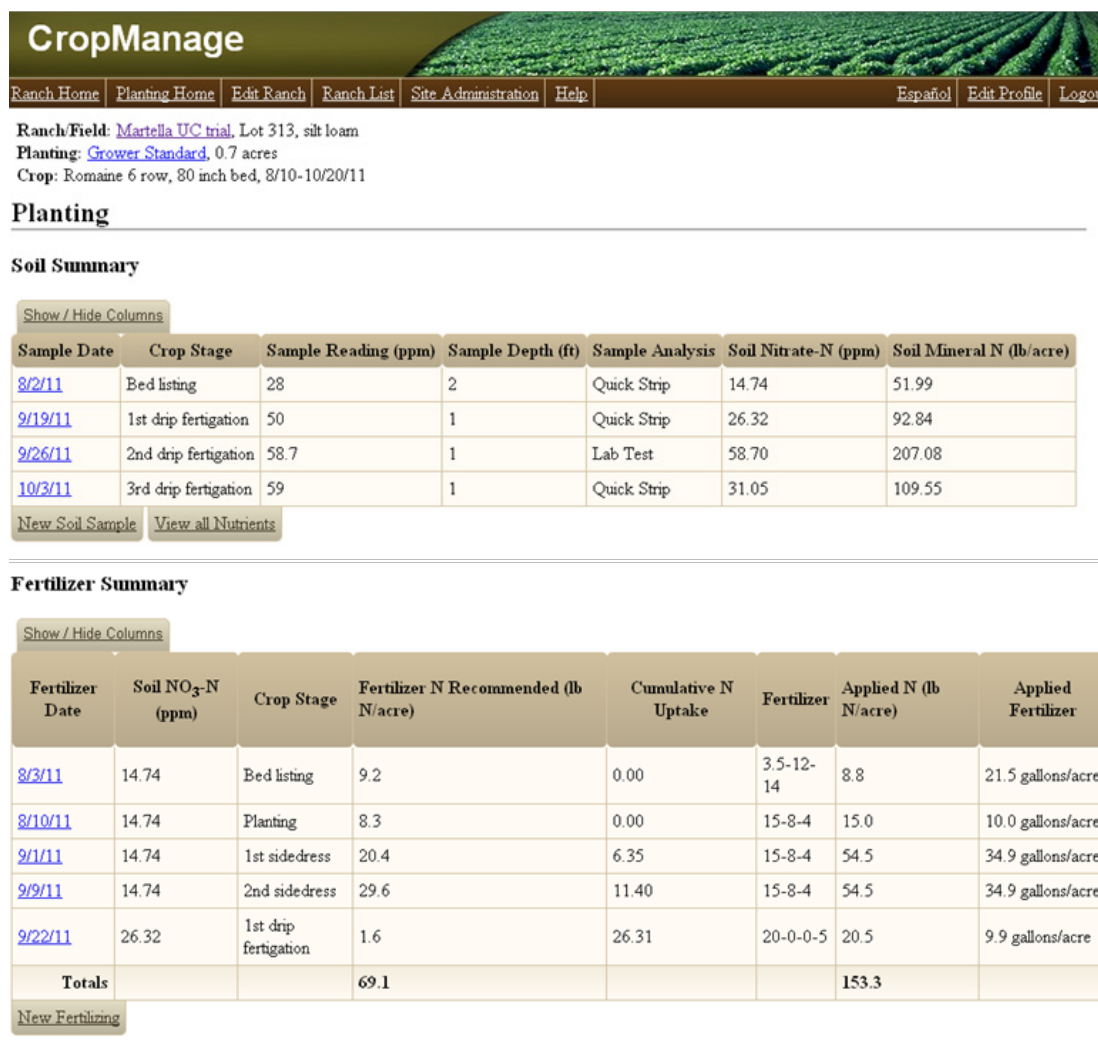

**Figure 1.** Example display of the soil test and the fertilizer summaries for a romaine lettuce crop.



During the second year of the project we improved many features in CropManage:

1. Soil test table was modified to accommodate entry for multiple nutrients and depths.
2. Irrigation table displays rain events and adjusts irrigation recommendations for significant rain events.
3. Flow meter data associated with a planting can automatically be imported into the irrigation table from a datalogger with internet access.
4. A Google map function allows users to determine the latitude and longitude of their ranch, information needed for importing spatial CIMIS data.
5. Features of the user-interface, such as scrolling tables and personalizing column order, were added to provide a more intuitive experience for the user.

### Nitrogen and Water Management Algorithms for Lettuce

In addition to storing and sharing records of soil tests, irrigations, and fertilizations, the software algorithms recommend N fertilizer rates and water applications appropriate for the stage of lettuce growth. The N fertilizer algorithm develops recommendations based on an N uptake curve for lettuce, soil mineral N status (quick N test data), as well as estimates of N mineralization contributed from the residue of the previous crop, and soil. The user must enter a fertilization date, a soil N test value, and estimated days until the next fertilization event. Future work will incorporate nitrate-N concentration of the irrigation water into the N fertilizer recommendation.

The irrigation scheduling algorithm uses CIMIS reference ET data, crop coefficient values for lettuce, soil water holding capacity, and the application rate of the

Show / Hide Columns		Show Previous Columns								Show Next Columns
Water Date	Irrigation Method	Recommended Irrigation Interval (days)	Recommended Irrigation Amount (inches)	Recommended Irrigation Time (hours)	Irrigation Water Applied (inches)	Kc	Canopy Cover (%)	Average Reference ET (inches/day)	Total Crop ET (inches)	
<a href="#">4/17/12</a>	<a href="#">Sprinkler</a>	N/A	N/A	N/A	0.94 in	0.00	0	0.00	0.00	
<a href="#">4/19/12</a>	<a href="#">Sprinkler</a>	0.7	0.35 in	1.15 hrs	0.49 in	0.70	0	0.19	0.26	
<a href="#">4/21/12</a>	<a href="#">Sprinkler</a>	0.6	0.40 in	1.34 hrs	0.61 in	0.70	0	0.22	0.30	
<a href="#">4/23/12</a>	<a href="#">Sprinkler</a>	0.6	0.38 in	1.28 hrs	0.58 in	0.70	0	0.21	0.29	
<a href="#">4/26/12</a>	<a href="#">Sprinkler</a>	1.3	0.09 in	0.30 hrs	0.28 in	0.48	0	0.14	0.20	
<a href="#">5/6/12</a>	<a href="#">Sprinkler</a>	2.9	0.41 in	1.36 hrs	1.30 in	0.16	2	0.19	0.31	
<a href="#">5/18/12</a>	<a href="#">Drip</a>	5.3	0.53 in	3.55 hrs	0.91 in	0.20	12	0.19	0.45	
<a href="#">5/22/12</a>	<a href="#">Drip</a>	6.5	0.24 in	1.61 hrs	0.74 in	0.23	21	0.22	0.20	
<a href="#">5/27/12</a>	<a href="#">Drip</a>	4.7	0.45 in	3.03 hrs	0.64 in	0.37	35	0.21	0.39	
<a href="#">6/1/12</a>	<a href="#">Drip</a>	3.4	0.70 in	4.65 hrs	0.44 in	0.56	52	0.21	0.59	
<a href="#">6/3/12</a>	<a href="#">Drip</a>	3.0	0.35 in	2.34 hrs	0.11 in	0.69	58	0.22	0.30	
<a href="#">6/7/12</a>	<a href="#">Drip</a>	2.7	0.78 in	5.23 hrs	0.78 in	0.78	68	0.21	0.67	
<a href="#">6/11/12</a>	<a href="#">Drip</a>	2.0	1.12 in	7.46 hrs	0.93 in	0.87	75	0.27	0.95	
<a href="#">6/16/12</a>	<a href="#">Drip</a>	2.1	1.36 in	9.07 hrs	0.77 in	0.93	80	0.25	1.16	
<a href="#">6/20/12</a>	<a href="#">Drip</a>	2.1	1.09 in	7.27 hrs	0.94 in	0.97	82	0.24	0.93	
<a href="#">6/25/12</a>	<a href="#">Drip</a>	2.1	1.38 in	9.17 hrs	0.65 in	0.98	84	0.24	1.17	
<a href="#">6/28/12</a>	<a href="#">Drip</a>	1.8	0.94 in	6.29 hrs	0.44 in	0.99	84	0.27	0.80	
<a href="#">6/29/12</a>	<a href="#">Drip</a>	1.9	0.29 in	1.95 hrs	0.20 in	0.99	84	0.25	0.25	
<b>Totals</b>			<b>10.87 in</b>	<b>67.02 hrs</b>	<b>11.75 in</b>				<b>9.20 in</b>	

New Watering View Flow Meter Data View Rainfall Data

Figure 2. Example display of irrigation table summary for a head lettuce crop. Hyperlinked values link to additional information.

irrigation system to estimate the appropriate irrigation interval and volume of water to apply to maximize lettuce growth and minimize deep percolation. The algorithm is based on the canopy model of Gallardo et al. (1996) for estimating evapotranspiration of lettuce:

$$\text{Canopy cover (\%)} = G_{\max}/(1 + \exp(A + B \times \text{day}/\text{Maxday})) \quad \text{eqn. 1.}$$

where  $G_{\max}$  is the maximum canopy cover,  $A$  and  $B$  are fitted parameters in **Table 1**,  $\text{day}$  is the number of day after planting and  $\text{Maxday}$  is the total days between planting and harvest. Parameters for this model were determined for iceberg and romaine lettuce types grown on 40 and 80-inch wide beds by taking overhead near-infra red canopy photos at 10 to 15 day intervals during the crop cycle.

Canopy cover is converted to a crop coefficient ( $K_c$ ) by a modified version of the equation published by Gallardo et al. (1996):

$$K_c = (0.63 + 1.5 C - 0.0039C^2)/100 \quad \text{eqn. 2.}$$

where  $K_c$  is the crop coefficient, ranging between 0 and 1, and  $C$  is percent canopy cover. Evaporation from the soil surface is also estimated by the method described by Gallardo et al. (1996) and used to develop the final  $K_c$  value used for estimating crop ET.

To obtain a recommended irrigation volume and interval, the user enters the irrigation date of the next irrigation and the software automatically obtains reference ET data from the nearest CIMIS weather station and uses the algorithms described above to estimate the crop coefficient. Additions to the second version of the software now allow the user to import spatial CIMIS reference ET data or reference data from the nearest CIMIS station. Spatial CIMIS data would presumably increase the accuracy of crop ET estimates for fields located in a different climatic zone than the

nearest CIMIS station.

Maximum soil moisture tensions set by the user are used to optimize the recommended irrigation interval. An algorithm relating volumetric soil moisture to soil moisture tension from soil texture data was developed to determine the maximum allowable depletion between irrigations.

### Field Testing and Grower Oversight of Software Development

We established a core group of growers to use, test, and review the first version of the irrigation and nitrogen management software. Four growers evaluated the software for their late summer and fall lettuce crops in 2011. Their suggestions were incorporated into a second version of the software that went online beginning in March 2012. Some of the suggestions that were made included:

1. Disclose UC policy on privacy of grower data.
2. Improve procedures for setting up new user accounts.
3. Ranch administrator should be able to determine level at which a user can access ranch data (view vs edit privileges)
4. Add calculator to estimate application rate of drip and sprinkler irrigation systems
5. Allow user to customize fertilizer list
6. Let user toggle units for entering volumes of applied water (inches, hours, gallons)
7. Let user toggle units for entering the amount of fertilizer applied (gallons, pounds/acre)
8. Add additional planting configurations for lettuce (42-inch wide beds)
9. Add additional vegetable crops and strawberries.

**Table 1.** Parameters for canopy cover algorithm (eqn. 1) for various lettuce types and planting configurations.

Bed Width (inches)	Lettuce Type	Plant Rows per Bed	Number of Sites	Model Coefficients			
				$G_{\max}$ (% cover)	A	B	$R^2$
40	Iceberg	2	7	83	6.780	-11.605	0.77
80	Iceberg	5	2	92	6.825	-12.768	0.93
80	Iceberg	6	2	89	8.234	-14.114	0.97
40	Romaine	2	2	85	3.877	-7.683	0.94
80	Romaine	5	3	86	7.072	-10.731	0.96
80	Romaine	6	7	82	7.058	-10.948	0.94

During the 2012 season we continued testing and demonstrating the CropManage software in 10 commercial lettuce fields on the central coast. We installed a flowmeter in each of these fields so that the grower could view the volume of water applied during irrigation events (Figure 3) and compare actual and recommended volumes of applied water (Figure 4). Participating growers were responsible for monitoring soil nitrate levels of their fields using the quick nitrate test, and entering these values and fertilizer applications

amounts into CropManage. We will also conduct trials comparing yield of lettuce grown under standard and CropManage recommended water and nitrogen management practices.

**LITERATURE CITED**

Gallardo, M., R.L. Snyder, K. Schulbach and L.E. Jackson. 1996. Crop growth and water use model for lettuce. J. of Irrig. and Drain. Eng. 122, No. 6: 354-359.

**Flow Meter Data**

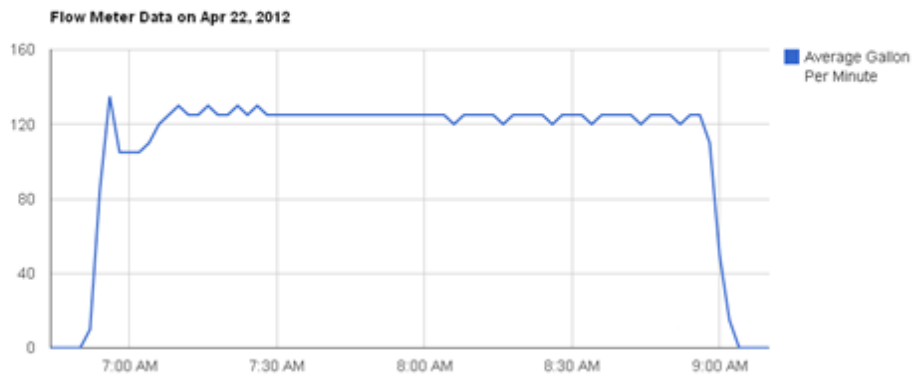

Figure 3. Display of flow meter data for a single irrigation event.

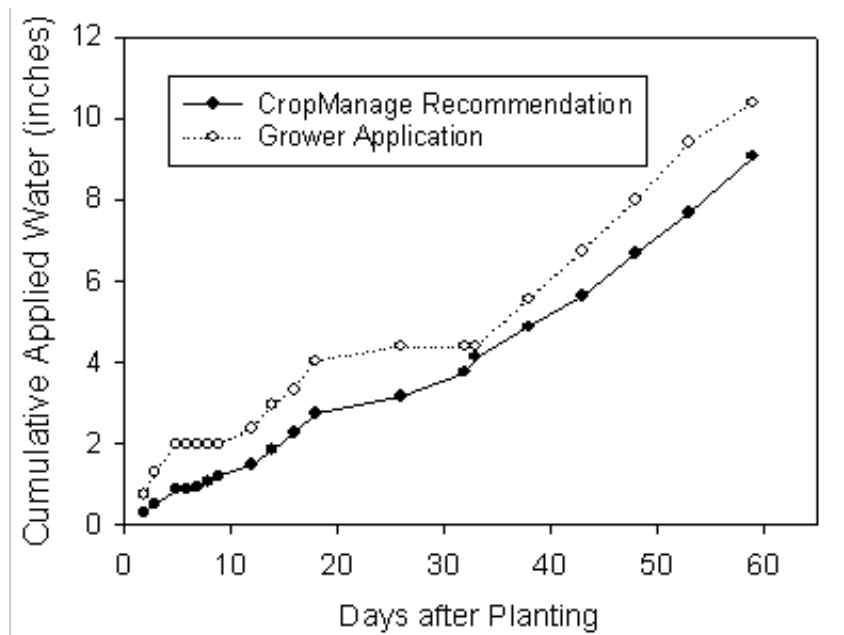

Figure 4. Comparison of actual and recommended irrigation water volumes for a commercial lettuce crop.



# Adjustable-Rate Fertigation for Site-Specific Management to Improve Fertilizer Use Efficiency

## PROJECT LEADER

**Michael Delwiche**  
Professor  
Dept. of Biological &  
Agricultural Engineering  
University of California  
One Shields Avenue  
Davis, CA 95616  
(530) 752-7023  
mjdelwiche@ucdavis.edu

## COOPERATOR

**Robert Coates**  
Development Engineer  
Dept. of Biological &  
Agricultural Engineering  
University of California  
One Shields Avenue  
Davis, CA 95616  
(530) 752-6731  
rwcoates@ucdavis.edu

## COOPERATOR

**Loren Oki**  
Cooperative Extension Specialist  
Dept. of Plant Sciences  
University of California  
One Shields Avenue  
Davis, CA 95616  
(530) 752-4135  
lroki@ucdavis.edu

## COOPERATOR

**Richard Evans**  
Cooperative Extension Specialist  
Dept. of Plant Sciences  
University of California  
One Shields Avenue  
Davis, CA 95616  
(530) 752-6617  
ryevans@ucdavis.edu

## COOPERATOR

**Lawrence Schwankl**  
Cooperative Extension Specialist  
Dept. of Land, Air, and Water  
Resources  
UC Kearney Agricultural Center  
9240 S. Riverbend Avenue  
Parlier, CA 93648  
(559) 646-6569  
schwankl@ucdavis.edu

## INTRODUCTION

Uniform application of dissolved fertilizer within large irrigation zones of commercial nurseries will over-fertilize some plants since the fertilizer requirement is based on those with the greatest need. Similar problems exist with many other specialty crops. By decreasing the size of the irrigation/fertigation zones and separating plants based on water and nutrient needs, site-specific fertigation can limit fertilizer waste and loss to the environment. However, using conventional fixed-rate injection may not be possible due to the time required to fertigate a large number of zones independently. It is possible to deliver different fertilizer rates to simultaneously-operating zones, but it is complicated (Coates et al., 2012). Zones can be fertigated at different rates by using different durations of fixed-rate fertilizer injection for each zone, but more effective control of fertilizer application could be achieved by automatic adjustment of the injection rate for each zone. The ability to automatically vary the rate of injection will provide greater flexibility to deliver fertilizer to multiple zones. With a simple and inexpensive injection system, a separate injector could be installed at each zone to provide a unique fertilizer delivery rate. Installation and management of injectors at small, site-specific

zones would be simplified by using wireless sensing and control technology.

In this project, we are developing simple technology to allow adjustable-rate fertilizer injection, which will then be integrated with a wireless control network. Our overall goal is to improve fertilizer use efficiency through site-specific fertigation.

## OBJECTIVES

1. Develop a simple fertilizer injection system to give adjustable-rate fertigation.
2. Integrate the injector with the wireless irrigation control system to give automated, adjustable-rate fertigation for nurseries.

## DESCRIPTION

In industry today, the four main types of fertigation systems are centrifugal pumps, positive displacement pumps, pressure differential methods, and methods based on the venturi principle (Haman, 1998). Each method has advantages and disadvantages.

The main advantage of pumping systems is that they can accurately inject fertilizer into the system and require no

feedback control. They are easy to install and have a high chemical resistance. Disadvantages are that pumps have moving parts and are expensive to buy and maintain. They also require an external power source to operate.

Pressure differential methods rely on water pressure to push or pull fertilizer into the irrigation line. Pressure differential injection has the advantage of being relatively inexpensive, but has the disadvantage that it often requires the injector to be located near the irrigation pump so that fertilizer can be injected on the suction side of the pump, which is not feasible for a site-specific system or system with a municipal water supply. Other methods use pressure from the irrigation line to push fertilizer into the line downstream. The systems for this typically require tanks that are frequently refilled or do not provide a constant rate of injection.

Venturi-based systems are powered by the water that flows through them. The main advantages are that they require no electrical power, and are relatively inexpensive and durable, since most are made from noncorrosive plastic. Disadvantages are that venturis cannot consistently inject the same amount of fertilizer over time because they require a pressure differential to operate and pressure changes occur frequently in real installations (Schwankl and Prichard, 2001).

We decided to use a venturi-based injector because they are relatively inexpensive, require no electrical power, and can easily have valves and metering devices installed. Venturi injection is based on a restriction in the cross-sectional area of a pipe, which increases the fluid velocity and decreases static pressure around the point of restriction. A suction line is connected to a port in the restriction area, which then allows injection of concentrated fertilizer stock solution. Typically the venturi is put in a by-pass of the main-line in order to create an adequate pressure differential to achieve

negative pressure on the suction line (Figure 1). A flow regulator or valve may be used to restrict flow. In our variable-rate fertigation system, an inline electrical conductivity (EC) sensor on the downstream side of the injector sends conductivity information back to a computer control board. The controller drives a solenoid valve at a fixed frequency and changes the duty cycle (percent of time valve is open) to adjust the average downstream fertilizer concentration to the desired value.

## RESULTS AND DISCUSSION

### Injection System Design

Our current prototype (Figure 2) consists of a 384 gal/hour venturi injector (Model 384, Mazzei Injector Company, Bakersfield, California, USA). It is plumbed in parallel with a main-line flow control valve that can be adjusted to achieve an adequate pressure differential across the venturi. A two-way, normally closed solenoid valve with an orifice diameter of 3/32" (Alcon Model 02BZ072B1-4CCF, Xylem Alcon, Santa Ana, California,

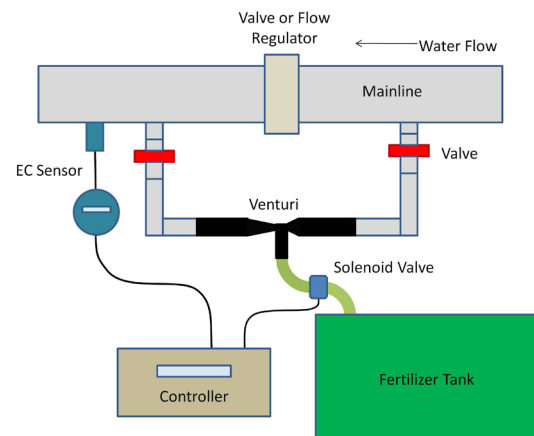

**Figure 1.** Diagram of the variable-rate injector using venturi, valve, and electrical conductivity sensor.

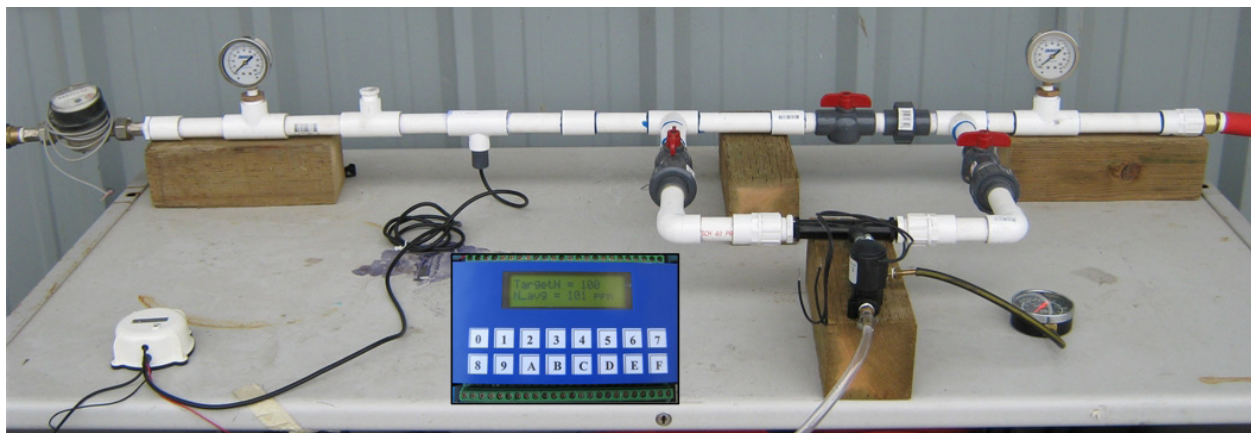

**Figure 2.** Variable-rate fertigation system, showing the venturi injector and solenoid valve on the fertilizer tank suction line, pressure gauges, inline EC sensor, and controller (inset).

USA) is on the suction line of the venturi. The inline EC sensor (Model CDH-722, Omega Engineering, Stamford, Connecticut, USA) has a probe connected to the outlet of the main-line and injector lines, and a display to show the measured EC.

The inline EC sensor has a working range from 0.00 to 9.99 mS/cm, corresponding to 0 to 2000 ppm nitrogen (N) in distilled water. We tapped into the circuitry of the EC sensor to gain access to an analog signal, which is measured by the controller. The EC sensor was calibrated with standards mixed from 20-20-20 fertilizer in distilled water and tap water, from 0 to about 2000 ppm N. Tap water at UC Davis has a background EC of about 0.53 mS/cm, which shifts the calibration curve up by an equivalent amount. EC measurements (mS/cm) were converted to nitrogen concentration, [N] (ppm), using the calibration equation slope and the background EC (mS/cm) measured before each injection by the equation:

$$[N] = (EC - \text{Background EC})/0.0039 .$$

Tests were completed with a 2000 ppm N stock solution in the fertilizer tank to examine the potential of the system to control the downstream fertilizer concentration. The first tests were done by pulsing the valve at a fixed duty cycle with a function generator, driver circuit, and 12 V power supply. Duty cycles of 0, 13, 27, 39, 50, 61, 72, 86, and 100% were tested at a drive frequency of 1 Hz. (A duty cycle of 0% means the valve is always off, and 100% means the valve is always on.) Average EC was measured during injection using the inline sensor and was compared with the EC of a water sample collected from the downstream emitters, measured using a bench-top EC meter. The injector ratio was calculated to be about 1:10. Therefore, with a 2000 ppm N stock solution, the fertilizer solution was expected to be 200 ppm N at 100% duty cycle and a

fraction of this at lower duty cycles (e.g., 100 ppm at 50% duty cycle).

Average nitrogen concentration measured with the inline sensor, expected nitrogen concentration based on the duty cycle, and nitrogen concentration of the sample collected at the emitter for duty cycles from 0% to 100% were compared. Both the inline EC and sample EC measurements resulted in slightly higher than expected nitrogen concentrations, although the trend showed that fertilizer concentration was proportional to the duty cycle of the suction valve. We expect that automatic adjustment of the duty cycle based on real-time EC measurements would improve the accuracy of injection.

### Controlled Injection

Automatic adjustment of the suction valve duty cycle was implemented with an embedded controller (TD40, Tern Inc., Davis, California, USA). The controller is a small computer board that is programmed to measure the EC sensor signal and output a pulse signal with variable duty cycle. The keypad prompts the user to enter the target fertilizer rate as parts-per-million nitrogen. The user then presses a button to begin background EC measurement and injection. The controller first monitors the background EC of water through the main-line. The user then partially or fully closes the main-line and opens the valves to the injector lines. The controller estimates the starting duty cycle and starts to pulse the suction line valve open and closed. During operation, the EC is continually monitored and a running average of the EC signal is calculated. EC is converted to nitrogen concentration and compared with the target concentration. The valve duty cycle is automatically decreased if the measured concentration is too high and increased if the measured concentration is too low.

If injected fertilizer concentration changes due to pressure changes across the venturi injector, poor stock

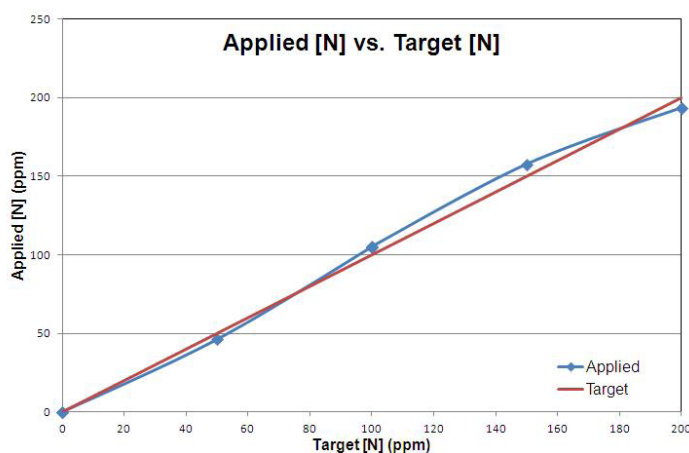

**Figure 3.** Target and measured nitrogen concentrations of fertilizer solutions delivered by adjustment of duty cycle to venturi suction valve.



mixing, or other conditions, the controller should automatically adjust the duty cycle to compensate.

**Figure 3** shows the target nitrogen concentration and the nitrogen concentration of the sample collected at the emitter for target concentrations of 0, 50, 100, 150, and 200 ppm N. The controller did well at applying fertilizer at the target rate.

### Wireless Control

The injection controller will be coupled to a wireless irrigation control network. In our previous FREP project we developed an experimental wireless network for site-specific irrigation and fertigation (Coates and Delwiche, 2009). Wireless nodes eliminate the need for wired valves, thus allowing simpler installation and management of small hydrozones. In this project, we have adopted a commercial version of the wireless network (eKo, MEMSIC Inc., Andover, Massachusetts, USA) that uses the same technology as our previous work. The eKo system was originally designed for sensors only, so we have added valve control capability.

To control fertigation at individual hydrozones, an injection controller would be connected to a wireless node at the inlet of each zone (**Figure 4**). This will allow individual control of fertigation levels in simultaneously operating hydrozones.

### CONTINUING WORK

Work will continue to develop the variable-rate injector (objective 1). It will then be integrated into the wireless mesh network (objective 2). The variable rate fertilizer

injector will be tested in commercial nurseries and experiments will be undertaken that apply different amounts of fertilizer to simultaneously operating hydrozones.

### LITERATURE CITED

- Coates, R. W., and M. J. Delwiche. 2009. Wireless mesh network for irrigation control and sensing. *Transactions of the ASABE* 52(3): 971-981.
- Coates, R. W., P. K. Sahoo, L. J. Schwankl, and M. J. Delwiche. 2012. Fertigation techniques for use with multiple hydro-zones in simultaneous operation. *Precision Agriculture* 13(2): 219-235.
- Delwiche, M. J., R. W. Coates, P. H. Brown, B. R. Hanson, R. Y. Evans, and L. R. Oki. 2009. Precision Delivery of Fertilizer to Satisfy Crop Demand. Pages 39-45 in *Proceedings of the Seventeenth Annual Fertilizer Research and Education Program*, California Department of Food and Agriculture.
- Haman, D. Z., A. G. Smajstria, and F. S. Zazueta. 1998. Chemical injection methods for irrigation. Agricultural and Biological Engineering Department, Florida Cooperative Extension Service, Institute of Food and Agricultural Sciences, University of Florida.
- Schwankl, L. J., and T. Prichard. 2001. Chemigation in tree and vine microirrigation systems. University of California. Agricultural and Natural Resources.

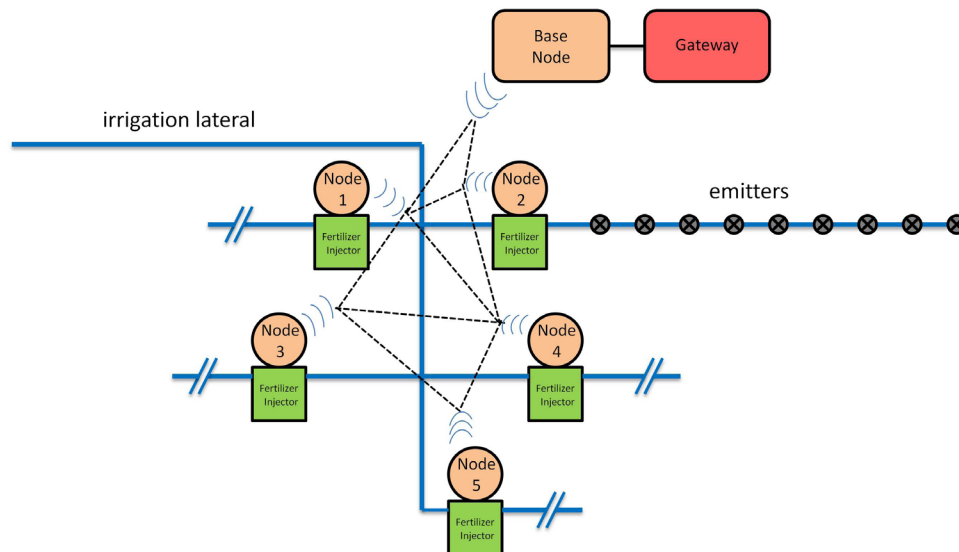

**Figure 4.** Wireless network for controlled fertigation.

# European Pear Growth and Cropping: Optimizing Fertilizer Practices Based on Seasonal Demand and Supply with Emphasis on Nitrogen Management

## PROJECT LEADER

### Kitren Glozer

Associate Project Scientist  
Department of Plant Sciences  
University of California  
One Shields Avenue  
Davis, CA 95616  
(530) 754-4096  
kglozer@ucdavis.edu

## PROJECT LEADER

### Chuck Ingels

Pomology, Viticulture, &  
Environmental Horticulture  
Advisor  
UC Cooperative Extension  
4145 Branch Center Road  
Sacramento, CA 95827-3823  
(916) 875-6913  
caingels@ucdavis.edu

## COOPERATOR

### Richard Elliot

Stillwater Orchards  
David J. Elliot & Sons  
PO Box E  
Courtland, CA 95615  
(916) 775-1027  
richard@stillwaterorchards.com

## COOPERATOR

### Jeff McCormack

John McCormack Co., Inc.  
PO Box 527  
Walnut Grove, CA 95690-0527  
(916) 776-1837  
mccormac@citlink.net

## INTRODUCTION

Best Management Practices (BMP) for European pear in California are being re-evaluated, using UC recommendations as a 'benchmark' starting reference. Recommendations currently are 2 lb actual N per ton of crop per acre per year ( $\text{lbN}_{\text{act}}/\text{t}/\text{A}/\text{yr}$ ). Tissue N critical value is 2.2%, adequate N range is 2.3-2.6%. The 2007 recommendation establishes BMP based on two physiological premises for N management: (1) efficiency of N use in cropping -- a 30 t/A orchard should receive  $60 \text{ lbN}_{\text{act}}/\text{A}/\text{yr}$ ; (2) vegetative vigor control-- no N if average shoot growth exceeds 12 inches. There is no 'one size fits all' approach to fertilizer management—some growers take the approach that inputs can be reduced or skipped on an annual basis if no adverse effects result (yield, fruit quality or tree deficiency symptoms) and tissue levels don't indicate inadequacy. Other growers tend to perceive reduction in N as a risk for reduced crop load and fruit size and that CV's established when tonnage was lower and most fruit went to processing (thus fruit size was less important), or fresh fruit were not stored, should be re-evaluated. Diagnostic methods for nutrient sampling will be re-examined in this study. Analyses after harvest do not allow adjustment for current season yields and quality, and it is possible that leaves collected from fruit-bearing spurs, where demand is likely to be highest, may prove to be a better indicator of nutrient status for cropping. Fruit quality is dependent on N, Ca, K, Mg and P (and their 'balance'); optima should reflect current strategy of maximum yield and 'target fruit'. High nitrogen is considered detrimental to fruit quality, as a balance among nitrogen, calcium and potassium, particularly.

## OBJECTIVES

1. Determine the relationship between seasonal tissue N partitioning and concentration and tree productivity and growth (i.e. reassess the currently-accepted leaf N critical values, timing of sampling and tissues tested). *Orchards Elliot 1 and McCormack*
2. Compare typical and reduced N to validate recommended N management and the possibility of customizing BMP based on tissue levels, fruit quality and crop load. *Orchards Elliot 1 and McCormack*
3. Quantify effects on crop load and fruit quality due to N, K and Ca as influenced by application amount, form and timing. *Orchard Elliot 2*
4. Refine current management guidelines for N, K and Ca usage to maintain productivity and fruit quality while reducing potential of over-fertilization. *Orchards Elliot 1 and 2, McCormack*
5. Monitor and quantify growers' irrigation practices in each trial site with the goal of optimum irrigation management to reduce nitrate leaching. Cooperate with growers to follow recommended irrigation frequency as outlined by UC recommendations (Pear Production and Handling Manual, UCANR Publication 3483, Mitcham and Elkins (eds), 2007). *Orchards Elliot 1 and 2, McCormack*

## DESCRIPTION

A practical approach has been adopted in which we use three ‘Bartlett’ orchards with existing conditions that allow manipulation of nutrients. These orchards represent the majority of Delta ‘Bartlett’ orchards with a range of yields of (20-32 t/A/yr), tree age, rootstock, soil and growing conditions. All are sampled annually for tissue nutrient levels, and irrigation water and soil N profiles. Orchards ‘*Elliot1*’ and ‘*Elliot2*’ are on Sutter Island and ‘*McCormack*’ is on Twin Cities Road, halfway between Interstate 5 and the Sacramento River.

### Elliot1

The typical N budget at this 100 year+ pear orchard for much of the last decade has been a total of 122 units of N balanced between spring and fall applications (**Table 1**). The orchard had low N 2007-2008 from the spring fertigation only, with adjustment in 2009 back to the traditional program outside our ‘LowN’ treatment area

for the trial begun in 2009 (a preliminary project, funded by the California Pear Advisory Board, in which *Elliot1* (60 #N<sub>act</sub>/A/yr) was compared to a ‘HighN’ orchard (120 #N<sub>act</sub>/A/yr) nearby). The ‘LowN’ treatment is annually adjusted to reflect crop load, to approximate UC recommendations, while the ‘HighN’ treatment is the grower’s ‘standard’ practice, adjusted by the grower annually for the orchard needs. Detrimental weather events, such as the hail damage received in late spring, 2011, resulted in the ‘Low N’ treatment (as in the rest of the orchard) receiving no spring N. Fertilization was not considered a justifiable expenditure by the grower.

In 2008, leaf analyses showed ‘normal’ nutrient levels with the exception of N (3.04%), excessive by UC standards. Soil pH was 6.33, nitrates 19.1 ppm, ammonium 1 ppm, and of other nutrients tested; only Mg (exchangeable) appeared excessive at 588 ppm. ‘Low’ to ‘very low’ soil nutrients included: soluble K, Ca, Mg, and B.

**Table 1.** N Fertilization practices, Elliot 1.

		Lb N (actual)/Acre/Year			Forms N	
		Spring	Fall	Total	Spring	Fall
2007		63	60	<b>123</b>	Ca(NO <sub>3</sub> ) <sub>2</sub>	(NH <sub>4</sub> ) <sub>2</sub> SO <sub>4</sub>
2008		63	0	<b>63</b>	Ca(NO <sub>3</sub> ) <sub>2</sub>	
2009		63	60	<b>123</b>	KNO <sub>3</sub> + Ca(NO <sub>3</sub> ) <sub>2</sub>	(NH <sub>4</sub> ) <sub>2</sub> SO <sub>4</sub>
		63	0	<b>63</b>	KNO <sub>3</sub> + Ca(NO <sub>3</sub> ) <sub>2</sub>	
2010	High N	0	60	<b>60</b>	No spring N in 2010 due to hail damage	(NH <sub>4</sub> ) <sub>2</sub> SO <sub>4</sub>
	Low N	0	0	<b>0</b>		
2011-2012	High N	60	60	<b>120</b>	KNO <sub>3</sub> + Ca(NO <sub>3</sub> ) <sub>2</sub>	urea
	Low N	0	0	<b>0</b>		

**Table 2.** Fertilization at McCormack orchard during trial period.

<b>2010</b>	<b>282#N/A North half, low vigor trees</b>	Fertigation 6x May-June = 129 #N from CAN17
		May 26 and June 30, 300 lbs./acre ea Ca(NO <sub>3</sub> ) <sub>2</sub> = 93# N/acre MOP (0-0-62): 322 lbs./acre = 200 lbs. K <sub>2</sub> O/acre = 166 lbs K/acre + Urea: 130 lbs./acre = 60 lbs. N/acre
	<b>129 #N/A South half, high vigor trees</b>	Fertigation 6x May-June = 129 #N from CAN17
<b>2011-2012</b>	<b>313.5 lbN/A North</b>	Fertigation 7x May-June = 150.5lbN from CAN17 May and June, 300 lbs./acre ea Ca(NO <sub>3</sub> ) <sub>2</sub> = 93lb N/acre; November, 630 lbs./A of a blend (11-0-44) = 70 lbs. N/A
	<b>150.5 lbN/A South</b>	Fertigation 7x May-June = 150.5lbN from CAN17



## Elliot2

We are testing N:K:Ca effects on fruit quality and cropping, as well as other nutrients which may have correlative effects. Our project compares application method and timing of K, as well as any effects of reduced N. Until 2007 the typical fertilizer program in *Elliot2* was 100 #N<sub>act</sub>/A/yr immediately after harvest and a fall application of potash (application of K is 'budget dependent'). In 2007 and 2008, no fertilizer was applied. Beginning in 2009, the block was fertigated in spring with KMend (potassium thiosulfate K<sub>2</sub>S<sub>2</sub>O<sub>3</sub>), soluble potash (K<sub>2</sub>O) at 25% and S at 17%, by weight, for a total of 150 lb K/acre. No reduction in vigor and no loss of yield (~25 tons/A) or fruit quality from 2007 onward has been reported by the grower. Urea (1#/100 gallons/acre) is applied in each fireblight spray for 'fruit finish', for a total of 0.7-2.76 #N/acre. The trial K treatments are either springtime split fertigations of calcium nitrate (total of 60#N each) and KMend or 300# K<sub>2</sub>O (muriate of potash; MOP (0-0-62): 300 lbs./acre = 186 lbs. K<sub>2</sub>O/acre = 154 lbs K/acre) or 154 #Kact/A/yr applied to soil in fall. The spring application allows adjustment of fertilizer quantity based on current season crop load, is applied during the time of greatest demand by growing fruit, and is thought to contribute to better 'fruit finish' and storage longevity.

## McCormack

This orchard is also being used to compare different rates of N to test customizing BMP. McCormack Orchard rows have a N-S orientation with a 'drop' towards the south half, with higher water table and better soil, resulting in increased vigor, earlier harvest, heavier crop load and larger fruit than in the N half. Recent management changes (flood changed to solid set sprinkler irrigation, increased N and better pruning) have increased yields from 20-23 t/A/yr to 30-32 t/A/yr. Both halves of the orchard received a total of 152#N<sub>act</sub>/A/yr until 2010. Prior to harvest, starting 2010, the orchard program shown in **Table 2** was begun to equalize fruit development rate, cropping and vegetative vigor between the N and S halves of the orchard.

In *Elliot1* and *McCormack* Orchards the relationship between tissue N partitioning, timing and level of N application with yield, fruit quality and vigor is addressed. At *Elliot2* tissue partitioning of N is also tracked, but the emphasis is on the effects of timing of K application (and method/form of application) on tissue macronutrient levels, fruit quality and yield (of selected scaffold limbs on sample trees, tracked annually). We are comparing early and late sampling of both vegetative and reproductive leaf tissues with 'standard' sampling (non-bearing spur leaves in late June-July) at all orchards; fruit

nutrient levels are tested at *Elliot2* as well. A collateral study of postharvest and storage fruit quality as affected by treatment was conducted at UC Davis in 2010, funded by the California Pear Advisory Board. A similar study was carried out in 2011.

## RESULTS AND DISCUSSION

### Elliot1: High N vs Low N, 'lean inputs'

**2010 Tissue analyses.** Three sample timings (late April, preharvest and pre-leaf fall) for N content of different leaf types (shoot, bearing and non-bearing spur) have shown partitioning into different plant organs (vegetative vs reproductive) independent of N level treatment, with leaf N values below the critical values set for mid-summer levels, illustrating both movement of N into storage tissues and probably removal of N with cropping. Leaf analyses from April and July, 2010 show significantly more N for shoot leaves and bearing spur leaves. Non-bearing spur leaves showed no difference and would not have served for early season diagnostic purposes. No deficiencies have been found and the tissue N content differential between leaf types is only consistent in shoot and bearing spur leaves (in July). Analyses from 2012 have not been completed.

**Harvest 2010.** No differential treatment had occurred by harvest, thus any yield and quality differences were due to inherent orchard, soil, drainage and tree characteristics; these will be tracked to better separate out actual treatment effects.

**Harvest, 2011.** Although means for yields per tree and acre (calculated from the same data) are numerically quite different, there are no significant differences, statistically, due to the distribution of the data (unequal variances). Treatment differences for fruit size were highly significant (0.1% level), even when this replicate effect was analyzed independently by the sub-sampling for size grade performed throughout the ongoing harvest. If both 2010 and 2011 harvest yields are analyzed together, to take the 'N treatment' carryover into account, the combined yields are not significantly different (estimated tons per acre, 2010+2011 are 44.0 for 'HighN' and 45.6 for 'LowN'). Harvest data from August, 2012 is being analyzed.

**Vegetative growth.** As measured by pruning weights, vegetative growth was not different between treatments indicating an insensitivity to N level by growing shoots. This insensitivity to large differences in applied N has been previously reported (Hewitt et al., 1967; Ramos et al., 1994; 'A Pear Pest Management Evaluation', Contract No. 99-0200 CDPR and CPAB; Ingels, CPAB report 2005). Ramos et al., 1994, concluded that 'Bartlett' pear tree is nitrogen tolerant and that excessive vigor could

not be controlled by N management, but only by water status--a next-to-impossible task for Delta orchards with high water tables. Furthermore, there was no correlation between July leaf N and dormant pruning weights, while there was a strong relationship between pruning weights and early season water potential. When we tested correlations between dormant pruning weights at Elliot1 and leaf N content in April, July and October, the best fit was between dormant pruning weights and April non-bearing spur leaf N. The relationship is quite weak with an R square of 0.0698.

**McCormack: High N, low vigor vs Low N, high vigor; balancing cropping by increasing vigor**

**Tissue N, 2010.** April, 2010 values for tissue N levels indicated significant differences in shoot and bearing spur leaves which must be due to inherent tree differences as influenced by 'location' within the orchard (data not shown). 'High N, Low vigor' trees are much smaller with lower vigor, less crop, so 'loss' of N to cropping and vegetative growth may be less, explaining why these leaves have more N. Also, heavier cropping tends to dilute mineral content found in leaves. In July, once differential N treatments were begun, the differences were less in shoot leaves and there were no differences in bearing spur leaves; October values were

not different.

Vegetative vigor, measured as pruning weights during the pruning process (Jan 28-Feb 3, 2011), were highly significant by treatment group when 'replicate' effects were analyzed as a random effect by the Mixed Model approach. Not unexpectedly, the 'Low N, High vigor' trees had much higher pruning weights than did the 'High N, Low vigor' trees (63.7 vs 43.2 lb, respectively; significant at 0.1%). It is expected that this difference will persist as a function of the orchard and mature trees, and is not likely to change due to N treatments, based on the proven insensitivity to N in pear.

**Harvest, 2010.** Yields in the first pick were significantly higher for the 'LowN, High vigor' treatment, which were virtually all #1 fruit (**Table 3**). Although overall yield was numerically higher in this treatment, no statistical significance was found, because of tree-to-tree variation. Total yield for the 'HighN, Low vigor' treatment was 81% of the 'LowN, High vigor' treatment (yield lb/tree), 68.6% for tons #1 fruit/acre, and 78.8% for %yield as the 1st harvest.

**Harvest, 2011.** Although yields were again lower in the 'High N, low vigor' treatment compared to the 'Low N (**Table 4**), high vigor' treatment, the ratio of the treatments for yield components was better than

**Table 3.** McCormack 2010 harvest yields and fruit quality. First harvest was a 'size' pick; all fruit in first harvest were #1 fruit of diameter 2-5/8" or greater. Treatments are the north half of the orchard (low vigor trees, 282# N<sub>actual</sub>/A/yr) and the south half of the orchard (high vigor trees, 129# N<sub>actual</sub>/A/yr).

N Treatment	Yield/tree(lb) at harvest			#1 fruit/tree (lb) 2 <sup>nd</sup> harvest	%Yield = 1 <sup>st</sup> harvest	%Yield of 2 <sup>nd</sup> harvest as #1 fruit
	1 <sup>st</sup>	2 <sup>nd</sup>	Total			
High N, low vigor	111b <sup>x*</sup>	180	291	128.4	37.9b <sup>*</sup>	71.2
Low N, high vigor	173a	187	360	142.4	48.1a	76.2

N Treatment	Estimated tons/A yield			Estimated #1 fruit (tons/A)			Fruit wt (oz)		
	1 <sup>st</sup>	2 <sup>nd</sup>	Total	1 <sup>st</sup>	2 <sup>nd</sup>	Total	#1 fruit		Fruit wt (smaller fruit)
							1 <sup>st</sup>	2 <sup>nd</sup>	
High N, low vigor	12.1b <sup>*</sup>	19.6	31.8	11.0b <sup>*</sup>	25.0	35	7.3	7.7	5.6
Low N, high vigor	18.8a	20.4	39.2	17.8a	33.2	51	7.2	7.6	5.6

in 2010 (in parentheses): 83.4% for total lb/tree yield (81%), 85.2% for tons #1 fruit/acre (68.6%), and 95% for %yield as the 1st harvest as ungraded fruit (78.8%). Several treatment differences for yield components were statistically significant by treatment at the 5% level.

Harvest 2012 data is being analyzed.

Overall, the following conclusions can be made about yields and fruit quality at McCormack:

- Improved percentage of the crop has been picked in the first harvest on the low vigor trees
- Little difference was found in the unsorted yield between treatments in the harvest
- In 2011 the low vigor yield in the first harvest increased to 95% of the high vigor yield (by percentage of the crop picked in the first harvest).
- Little difference in the percentage of that harvest that was #1 fruit
- 2010 the low vigor trees yielded 81% of the estimated total tonnage per acre that the high vigor trees yielded
- 2011 the low vigor trees only yielded 75% of the unsorted, estimated tonnage of the high vigor trees, but 85% of the #1 fruit tonnage per acre.

- For 2010+2011 the total estimated, unsorted tonnage/A of the low vigor trees was 86% of the high vigor trees and 80% of the estimated, #1 fruit tonnage/A

### Elliot2: Fruit quality and nutritional relationships

**2010 Tissue analyses.** Any differences in nutrient content at the first sampling in April would not be due to the treatment program for this trial, as differential treatments had not been imposed until May, 2010 (data not shown). Therefore, differences in nutrient content which are not due to replicate effects (tree quadrants within a treatment group) may be due to 'orchard location' differences, e.g. soil heterogeneity or drainage. Because these differences due to location are suspect, we will continue to track this possibility.

Bearing spur leaves in April, 2010 (no differential treatments applied yet):

- N content is high in shoot leaves and non-bearing spur leaves, lower in bearing spur leaves
- In the 'Y1+2' treatment, K is elevated, Mg is reduced, the N/K ratio is reduced, and the (K+Mg)/Ca and K/Ca ratios are higher compared to the 'Y1' treatment. Other nutrients elevated in the 'Y+2' group include B, Mn and Cu.

**Table 4.** McCormack 2011 harvest yields and fruit quality. First harvest (August 1) was a 'size' pick to minimum diameter 2-1/2". The second harvest occurred August 15.

N treatment and vigor	Yield, ungraded						Yield, #1 fruit					
	Lb/tree			Tons/acre			Lb/tree			Tons/acre		
	1 <sup>st</sup>	2 <sup>nd</sup>	Total	1 <sup>st</sup>	2 <sup>nd</sup>	Total	1 <sup>st</sup>	2 <sup>nd</sup>	Total	1 <sup>st</sup>	2 <sup>nd</sup>	Total
High N, low vigor	143*	247	390	15.6	26.9	42.5	135	231	366	14.7	25.2	39.9
Low N, high vigor	179	286	465	19.5	31.2	50.6	166	263	429	18.1	28.3	46.8

N treatment and vigor	Wt #1 fruit (oz)		%Each harvest #1 fruit			%Crop as 1 <sup>st</sup> harvest
	1 <sup>st</sup>	2 <sup>nd</sup>	1 <sup>st</sup>	2 <sup>nd</sup>	Total	
High N, low vigor	7.4	7.6	95	94	94	36.6
Low N, high vigor	7.5	7.6	93	92	92	38.5

\* Means separation by LS Means, 5% level. Percentage data means separated based on arcsine square-root transformation (actual means shown).

**Table 5.** July, 2010 Nutrient values for for ‘Bartlett’ pear, Elliot2 orchard. Potassium was applied by fertigation ( $K_2S_2O_3$  (28 #K<sub>actual</sub>/A/yr) either in Spring, 2009 + Spring 2010 (Y1+2), or only Spring, 2009 (Y1). The Spring 2009 “Year 1” treatment was subsequently treated with 500# K<sub>2</sub>O=150 #K<sub>actual</sub>/A in Fall 2010.

	Bearing Spur Leaf		Shoot Leaf		Optimum for mid-summer shoot leaves
	Year 1+2	Year 1	Year 1+2	Year 1	
N (%)	2.7 a****	2.1 b	2.6 a***	<b>2.1 b</b>	2.3-2.7
P (%)	0.14 a***	0.12 b	0.2 a***	<b>0.1 b</b>	0.14-0.20
K (%)	1.0	1.1	<b>1.0</b>	<b>1.1</b>	1.2-2.0
Ca (%)	1.0 b***	1.6 a	<b>1.0 b***</b>	1.6 a	1.4-2.1
Mg (%)	0.38 b*	0.47 a	0.43 b*	0.50 a	0.3-0.5
S (ppm)	1563 a***	1352 b	<b>1628 a***</b>	<b>1338 b</b>	1700-2600
Fe (ppm)	74 b*	94 a	90	107	60-200
Mn (ppm)	55 b***	93 a	<b>35 b***</b>	76 a	60-120
Zn (ppm)	26	32	23.6 b***	27.5 a	20-50
Cu (ppm)	10.6 a*	9.4 b	10.1 a*	9.4 b	9-20
B (ppm)	25	25	27	25	20-40
(K+Mg)/Ca	1.3 a***	1.0 b	1.4 a***	1.0 b	
K/Ca	1.0 a***	0.7 b	1.0 a***	0.7 b	0.98-1.2 <sup>y</sup>
Mg/Ca	0.4 a***	0.3 b	0.4 a*	0.3 b	
N/Ca	2.6 a***	1.3 b	2.7 a***	1.3 b	
N/K	2.7	1.9	2.8	1.9	

\* Mean separation within plant part and nutrient by LSMeans, P = 0.05; different letter following value denotes significant difference within given nutrient and leaf type. \*, \*\* and \*\*\* indicate significance at 5%, 1% and 0.1%, respectively. Bolded values for mid-shoot leaves from extension shoots in mid-summer are low, (van den Ende and Leece, 1975).

<sup>y</sup> Range of K:Ca that induces moderate to high chlorosis (Linder and Harley, 1944).

**Table 6.** Comparison of yields from ‘sample’ tree scaffold limbs, 2010 vs 2011, by K treatment. ANOVA, nested model tested ‘location’ (rep, tree (rep)) and treatment (treatment, treatment x rep) effects.

Harvest year and applied K		Harvest									
		Total lb harvested				Total #fruit			Total #1 fruit		
		1	2	1+2	2010+2011	1	2	1+2	1	2	1+2
2010	Yr1-3 Spring fertig	18*	29	47a*		42	75	117	42.3	43.8	86.1
	Yr1 Spring fertig Yr2 Fall soil	19	26	45b		48	63	111	47.9	38.2	86.1
2011	Yr1-3 Spring fertig	34	27a*	61	108a*	92	75a*	167.9	92.5	61.1	153.6
	Yr1 Spring fertig Yr2 Fall soil	32	23b	55	99b	85	61b	146.1	85.2	51.1	136.3

\* Mean separation within column and year by DMRT, P = 0.05; different letter following value denotes significant difference. \*, \*\* and \*\*\* indicate significance at 5%, 1% and 0.1%, respectively.



**July, 2010.** Differential treatments were begun; some nutrients are deficient (**Table 5**). Many treatment differences are highly significant.

**October, 2010.** The only noteworthy difference between treatments was in spur and shoot leaves, with K significantly lower in the Y1+2 treatment, and Mg significantly higher in bearing spur leaves.

**Harvest, 2010.** No significant differences were found between fertilizer treatments for any yield components or fruit quality measures at harvest (data not shown).

**PostHarvest, 2010.** In the postharvest study, after 6-7 days without storage, firmness was significantly reduced in all stored fruits that received the higher rates of N (Y1+2) and physiological disorders of internal browning and senescent scald were evident in those fruit.

Multivariate analysis found that a forward stepwise multiple regression model of postharvest firmness due to K treatments explained treatment differences at 0.1% level with bearing spur leaf levels of Mn and Fe (1%), (K+Mg):Ca and K:Ca (0.1%) and Mg:Ca (5%).

**Nutrient relationships.** Of those nutrients most often associated with fruit quality and/or physiological disorder in 'Bartlett' pear, the following correlations were found:

- N negatively correlated with K (as N increased, K decreased), and therefore also with K+Mg/Ca, K/Ca. Although no correlation was shown for N with Ca or Mg, Mg:Ca was strongly and negatively correlated with N. All were highly significant.
- Negative correlation with P: Ca, Mg, Zn, Mn, Fe (strongly); S (weakly).
- Positive correlation with P: B, K+Mg/Ca, K/Ca, Mg/Ca and N/Ca (strongly).
- Negative correlation with K: S (moderately), Cu, Mg/Ca, N/Ca (weakly).
- Positive correlation with K: none
- Negative correlation with B: Ca, Mg, Zn, Mn, N/Ca (strongly), K+Mg/Ca, K/Ca, Mg/Ca (moderately)

While N was not positively correlated with firmness, nor K negatively correlated with firmness, the binary ratio was important to firmness with storage. K/Ca is thought to negatively influence firmness (Marcelle, 1995) yet this ratio was higher in both spur and shoot leaves of the Year1-3 pears, which had better firmness.

**April, 2011 Tissue analyses:** No differences in single nutrient values or nutrient ratios were found and values were within normal ranges.

**Harvest and Postharvest 2011:** In the 2011 harvest

spring-fertigated fruit were slightly smaller on average and #1 fruit less numerous than fruit from the treatment of spring (Yr 1) and fall (Yr 2), but differences were minor. Fruit from the Yr1 Spring + Yr2 Fall treatment, however, had reduced firmness after 7 days without storage, postharvest.

When harvests from 2010 and 2011 were compared (**Table 6**) we found that crop load was much larger in 2011 than in 2010. In the second harvest of 2011 the crop load of Yr1-3 trees was higher than those of Yr1 spring+Yr fall treatment; total yield was higher in the first treatment as well. Number of fruit was greatly increased for both treatments in this crop year, and significantly more in Yr1-3 trees when 2010 and 2011 were combined. Harvest data from 2012 is being analyzed.

The following conclusions can be drawn from the 2010 and 2011 harvest results:

- Fruit size slightly better with Spring fertigation
- But more #1 fruit with Fall K
- 2010 + 2011 Slightly better yield for 2 years with Spring fertigation on limbs
- Both years firmness after storage reduced ~1 lb by Spring fertigation
- 2010 K/Ca ratio in fruit is high – predictive of potential fruit quality problems

## LITERATURE CITED

- Hewitt, A.A. 1967. The effects of nitrogen fertilization on some fruit characteristics in Bartlett pear. J. Amer. Soc. Hon. Sci. 91:90-95.
- Marcelle, R. 1995. Mineral nutrition and fruit quality. Acta Hort. (ISHS) 383:219-226.
- Ramos, D.E., K.A. Shackel, L.J. Schwankl, E.J. Mitcham, S.A. Weinbaum, R.G. Snyder, W. Biasi and G. McGourty. 1994. Relationship between n fertilization, irrigation, yield, vegetative vigor and canopy exposure, fruit size and quality, and postharvest biology of Bartlett pears. Research Report California Pear Advisory Board.

## ACKNOWLEDGEMENTS

We wish to acknowledge the support of the California Department of Agriculture's FREP program and the California Pear Advisory Board for their support, as well as the growers and PCAs, without whose inputs and cooperation, this work could not be done.

# Developing Testing Protocols to Assure the Quality of Fertilizer Materials for Organic Agriculture

## PROJECT LEADER

**W.R. Horwath**  
Professor of Soil  
Biogeochemistry  
Department of Land, Air &  
Water Resources  
One Shields Ave.  
University of California  
Davis, CA 95616-8627  
(530) 754-6029  
wrhorwath@ucdavis.edu

## CO-PRINCIPLE PROJECT LEADER

**S.J. Parikh**  
Assistant Professor of  
Soil Chemistry  
Department of Land, Air &  
Water Resources  
University of California  
One Shields Avenue  
Davis, CA 95616-8627  
(530) 752-1265  
sjparikh@ucdavis.edu

## INTRODUCTION

The motivation for this research stems from increasing concerns regarding the amendments used in organic production (see, for example, CCOF's *Certified Organic* magazine, Spring 2007 and Spring 2009). These concerns include known adulteration of organic fertilizers with synthetic chemicals to increase profit margin; increasing suspicion of manufacturers by certifiers, growers, the Organic Materials Review Institute (OMRI), and the California Department of Food and Agriculture; public distrust; and the cost of watchfulness and enforcement of new policies such as third party on-site inspections.

Fertilizer labeled as "suitable for organic production" sold to growers of organic produce is in need of methodology to validate its authenticity. There is an urgent need to bring more transparency and authentication to the array of organic fertilizer products on the market.

## OBJECTIVES

This project contributes to better organize the characterization of materials that can be used in manufacturing and testing of organic fertilizers and amendments, and is supplemented with information from our own analyses. The major new product generated by this project is a method of detecting, with high probability, adulteration of organic fertilizers and other amendments by synthetic fertilizer and other chemical nutrient sources. The following objectives have guided this research project.

1. Construct a database of materials used in organic and synthetic fertilizers and their quantifiable properties through thorough search of the literature and additional chemical and physical analyses of such materials.
2. Establish natural ranges for the chosen properties of these materials that can be used to distinguish between pure, or unadulterated, and adulterated materials.
3. Develop a stepwise protocol test that labs and regulatory agencies can follow to identify organic fertilizers that have likely been adulterated by synthetic fertilizers.
4. Carry out blind tests with collaborating test labs to evaluate the above protocol.
5. Disseminate the results and products of the project to potential users, such as organic fertilizer test labs and regulatory agencies.

## DESCRIPTION

A comprehensive literature review on organic materials used in organic fertilizer formulations has been conducted (Task 1 is complete). We are continuing to assemble a comprehensive database of quantifiable properties of naturally occurring substances used in organic fertilizers, potential synthetic adulterants (i.e. synthetic fertilizer), and organic fertilizers and soil amendments (Task 2 ongoing). This task is almost complete; however, we will accept additional samples as

they are submitted. Examples of quantifiable properties are the natural stoichiometric elemental composition, ammonium content, attenuated total reflectance (ATR) Fourier transform infrared (FTIR) spectroscopy, FT-Raman spectroscopy and the stable isotope ratios of carbon, nitrogen, and oxygen. The data for this database is both from the scientific literature and through analyses of raw materials, organic fertilizers and soil amendments, and synthetic fertilizers in our laboratory and at the UC Davis Stable Isotope Facility. Expected ranges of values for each of the properties of interest are being determined from the multitude of data collected (Task 3 ongoing). Additional correlation analysis will be used to validate the source and makeup of the primary fertilizer ingredients.

Once the datasets have been evaluated and principal trends of properties have been validated, guidelines that outline how an organic fertilizer material is to be tested will be developed (Task 4 ongoing). We will

start collaborating with participating test laboratories to distinguish between adulterated and unadulterated materials in “blind” tests by following the protocols (Task 5 initiated). The database will be publicly available and serve as a resource and means to standardize guidelines and protocols for the organic fertilizer industry. Once developed, we hope the outcome of the proposed work will then be used by regulatory agencies to create a framework to effectively deal with adulterated organic fertilizers and soil amendments.

## RESULTS AND DISCUSSION

Nitrogen isotope ratio, carbon to nitrogen ratio, and ammonium content were identified as most useful for initial inspection of the database and evaluation of fertilizers. Databases of “natural” or expected values for certain parameters were created from laboratory organic fertilizer analyses and a review of raw materials and organic fertilizer literature (Figures 1-3). All data are

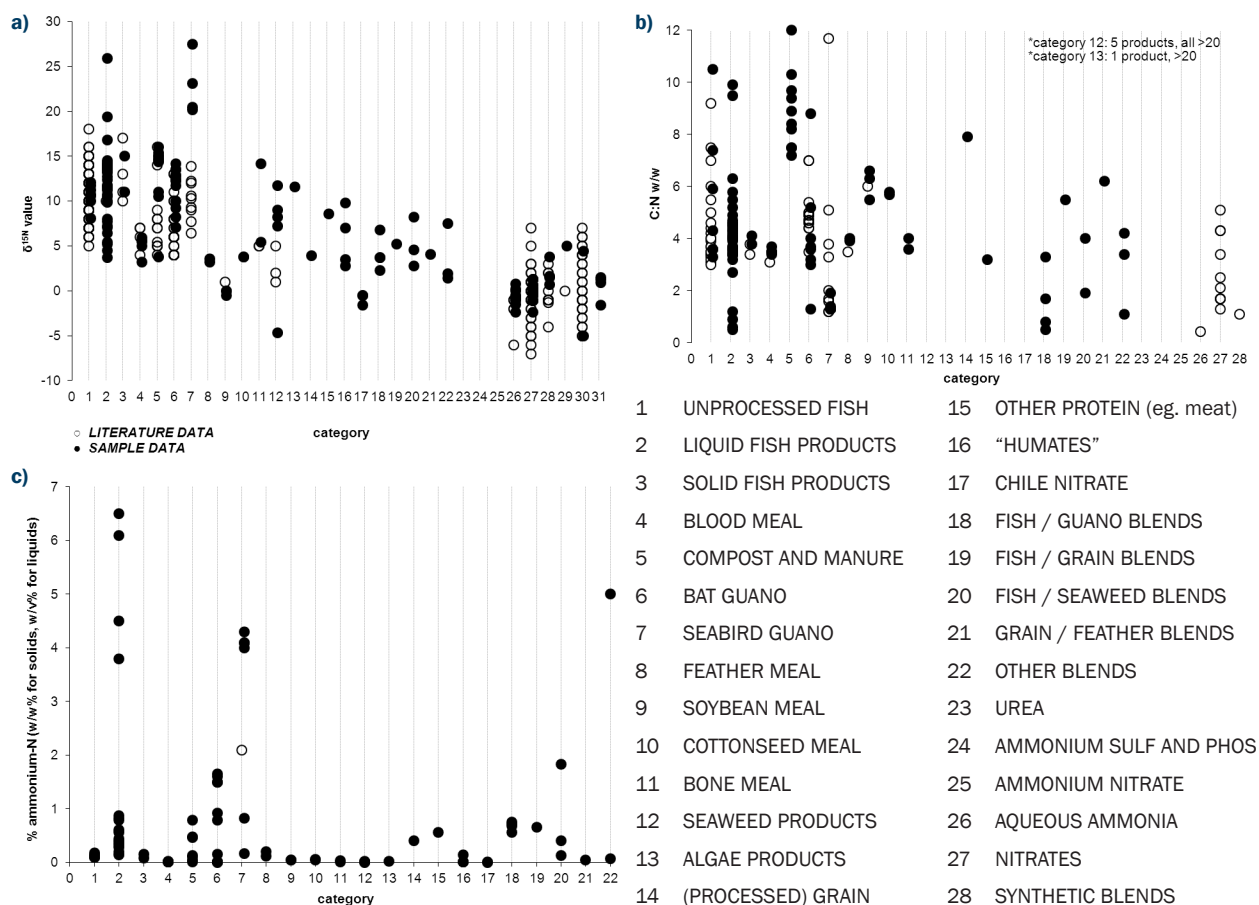

**Figure 1.** Graphical summary for a) the nitrogen isotope ratios; b) C:N and c) % ammonium -N content data compiled from literature and analysis of organic fertilizer samples.

shown together, including possibly adulterated products, resulting in a large spread of data in some cases.

Organic fertilizers collected were classified into categories used by OMRI namely: unprocessed fish, liquid fish products, solid fish products, blood meal, compost and manure, bat guano, seabird guano, feather meal, soybean meal, cottonseed meal, bone meal, seaweed products, algae products, processed (hydrolyzed or fermented) grain products, other non-fish and non-grain protein (e.g. meat hydrolyzates), “humates” and “humic acids”, Chile nitrate, fish/guano blends, fish/grain blends, fish/seaweed blends, grain/feather blends, and other blended products. The synthetic material categories were: urea, ammonium sulfate or phosphates, ammonium nitrate, aqueous ammonia, nitrates, synthetic blends.

Infrared spectra of the major classes of organic fertilizer currently available in California, such as fishmeal, liquid fish hydrolyzate, fish emulsion, blood meal, feather meal and guano using single bounce attenuated total reflectance (ATR) FTIR spectroscopy (Thermo Nicolet 6700, Madison, WI) were collected. These spectra, combined with those from several synthetic fertilizers have been combined to create a database of approximately 160 spectra. The spectral database currently consists of fish (liquid, solid and unprocessed), guano, blends, compost, seaweed, ammonia, bloodmeal, and feathermeal fertilizers. A variety of other fertilizers including soy meal, urea and Chile nitrate are also included.

Clear trends based on fertilizer class are evident making this an important point of reference for future spectral

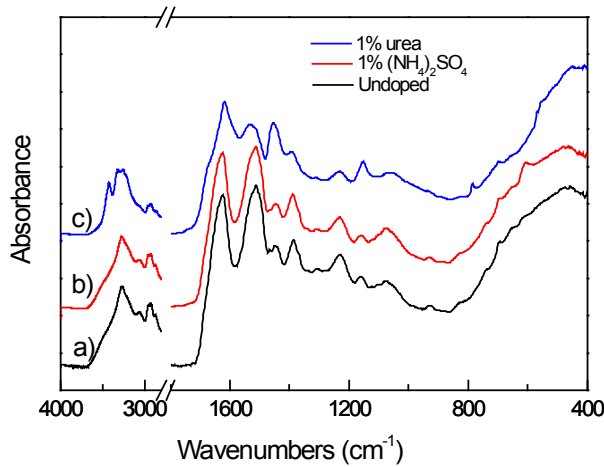

**Figure 2.** ATR-FTIR spectra of bloodmeal fertilizer a) undoped; b) doped with 1% ammonium sulfate and c) doped with 1% urea.

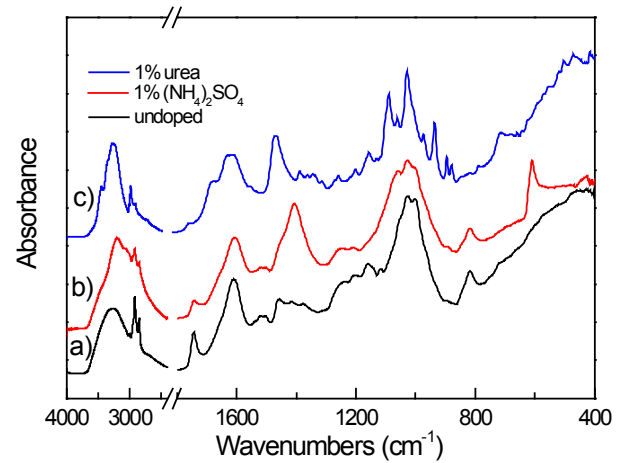

**Figure 3.** ATR-FTIR spectra of seaweed fertilizer a) undoped; b) doped with 1% ammonium sulfate and c) doped with 1% urea.

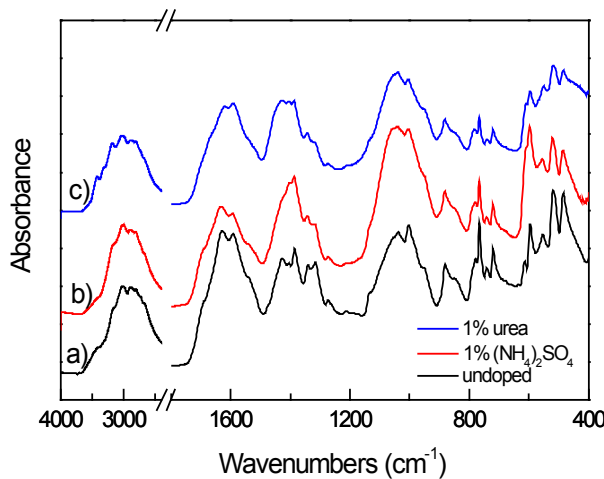

**Figure 4.** ATR-FTIR spectra of seabird guano fertilizer a) undoped; b) doped with 1% ammonium sulfate and c) doped with 1% urea.

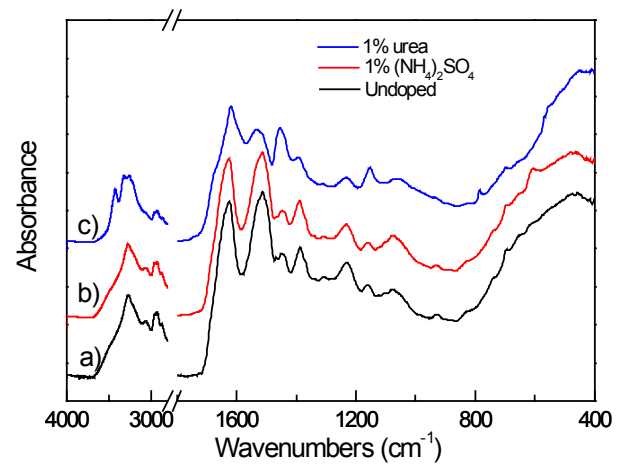

**Figure 5.** ATR-FTIR spectra of compost fertilizer a) undoped; b) doped with 1% ammonium sulfate and c) doped with 1% urea.



comparison. Selected fertilizer samples were doped with ammonia sulfate and urea (potential adulterants) to test the robustness of ATR-FTIR in detecting their presence (Figures 2-5). The presence of the adulterants was easier to detect in the spectra of bloodmeal and seaweed compared to the seabird guano and compost. However if post processing of the spectra was performed (i.e., spectral subtraction), it was possible to detect the presence of the adulterants in all the doped samples.

FT-Raman analysis of the organic fertilizer samples was also performed, also revealing clear trends based on fertilizer class. As done for FTIR analysis, selected organic fertilizer samples were doped with the adulterants prior to analysis. The FT-Raman analysis proved to be more effective than FTIR at detecting the presence of the adulterants with no post processing of the spectra required (Figures 6-9).

Prominent peaks for ammonium sulfate ( $1004\text{ cm}^{-1}$ : symmetric  $\text{SO}_4^{2-}$  stretching) and urea ( $1017\text{ cm}^{-1}$ : symmetric N-C-N stretching) were observed in the

feathermeal, bloodmeal and liquid fish spectra (Figures 6-8) enabling easy and quick detection. However, due to the complex sample matrix that caused scattering of the Raman signal resulting in a large background noise signal, detection of adulterants was somewhat more challenging in spectra of the compost samples (Figure 9). One drawback to this technique is that the greater signal to noise (S/N) ratio of this technique resulted in longer analysis times (8 min per sample) per sample compared to ATR-FTIR (4 min per sample).

As a result of the above analyses, a preliminary protocol is presented for identifying products which may have been adulterated, integrating all of the literature and laboratory information obtained until now. The suggested evaluation process was selected based on an order of increasing effort and expense. Initially, identifying the category to which a sample belongs is necessary in order to interpret the results of analysis, since values which are suspect for one kind of sample may not be suspect for another kind.

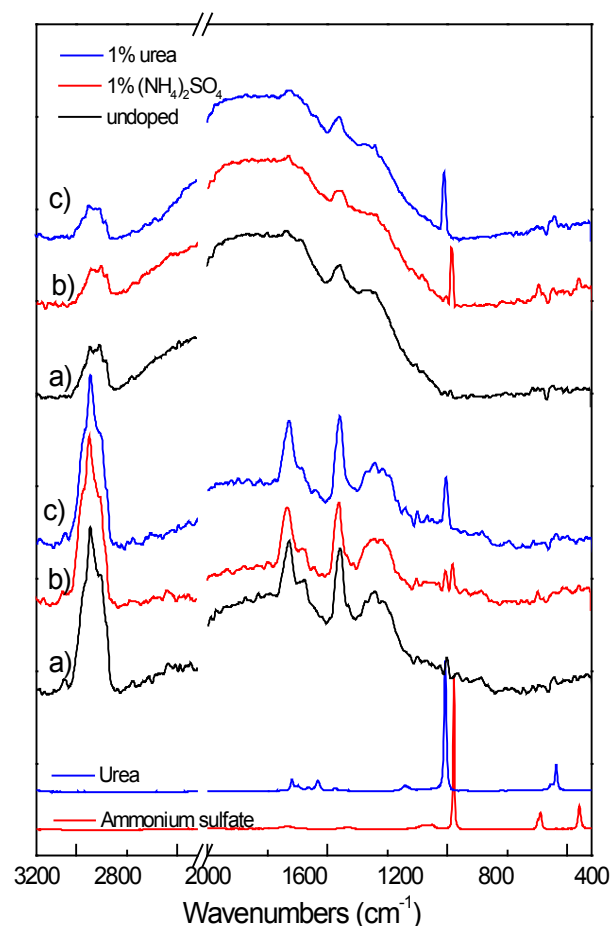

**Figure 6.** FT-Raman spectra of two feathermeal fertilizers a) undoped; b) doped with 1% ammonium sulfate and c) doped with 1% urea.

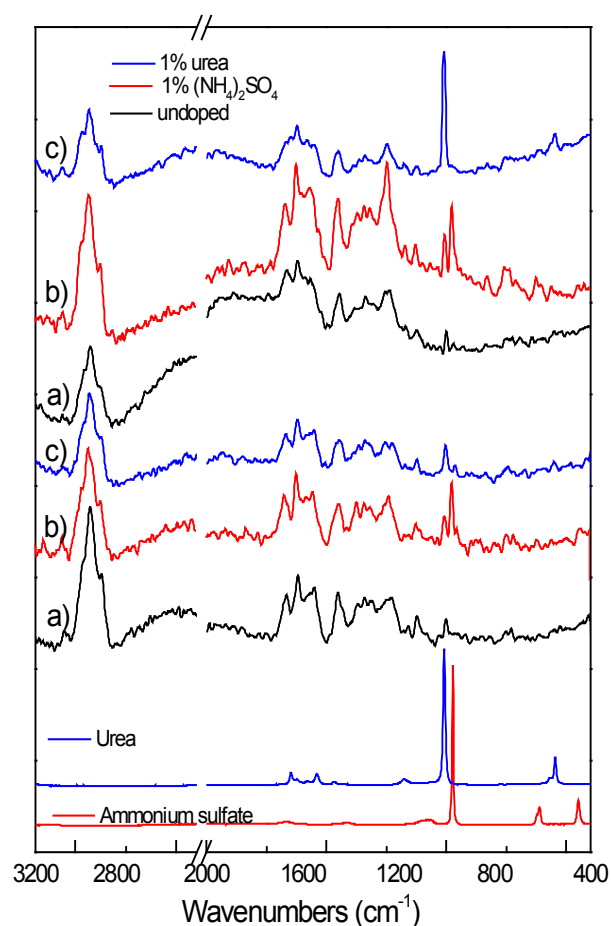

**Figure 7.** FT-Raman spectra of two bloodmeal fertilizers a) undoped; b) doped with 1% ammonium sulfate and c) doped with 1% urea.

**Step 1.** Prior to any laboratory analysis, or if the list of products in question is extensive, attention may be directed toward the label and/or price of a product as a simple way to identify where to begin analytical efforts.

**Step 2.** As a first step to evaluating a product, the ammonia (ammonium) content may be estimated in the field. For common, well-characterized categories of products such as liquid fish and fish blends, this is an easy preliminary step toward selecting samples for further evaluation. The unprocessed fish, seaweed, and grain from which such products are derived do not contain much ammonium. Upon processing (e.g., by heat or enzymes), this may increase up to approximately 1% (w/v, as nitrogen). Any product in these categories found to contain more than 1% nitrogen as ammonium (10000 ppm) should be retained for further analysis. If the product claims to be unprocessed, more than 0.5% may indicate the addition of ammonium or urea. Dilution of liquid fish products may disguise an addition of ammonium, but such products are not likely to be diluted since they are preferred in concentrated form.

**Step 3.** The ratio of carbon to nitrogen (C:N, w/w) in any material is a good indication of how “organic” a material is. It is not necessary to check the ammonium concentration if C:N is determined. The nitrogen in organic materials is derived primarily from protein, for which the C:N does not fall below 1. The same is true of guano, although guano may contain much of its nitrogen in the form of uric acid rather than protein. However, while theoretically possible, this is a conservative value, since it is rare that any protein would have a C:N of less than about 2, and for practical purposes any product with a C:N less than 2 may be suspected of having been adulterated with additional nitrogen. For guano, a reasonable threshold, based on literature values and the current database, is a C:N of 1. An obvious exception is Chile nitrate, an approved product with a naturally high level of nitrogen relative to carbon.

**Step 4.** The ratio of nitrogen-15 to nitrogen-14 (expressed as  $\delta^{15}\text{N}$ ) is another parameter which rarely falls below a certain threshold value in natural material, with few exceptions. Fish tissue and guano, for

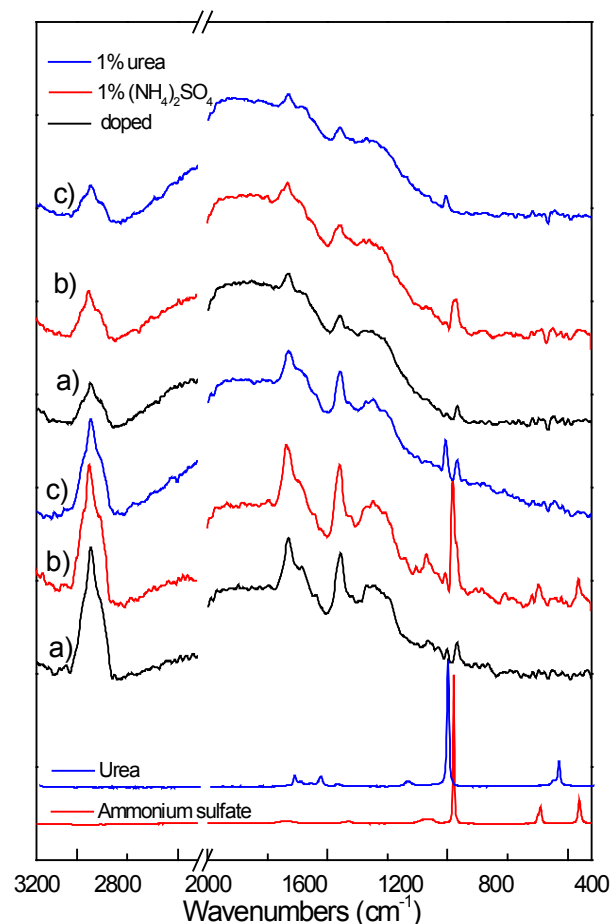

**Figure 8.** FT-Raman spectra of two liquid fish fertilizers a) undoped; b) doped with 1% ammonium sulfate and c) doped with 1% urea.

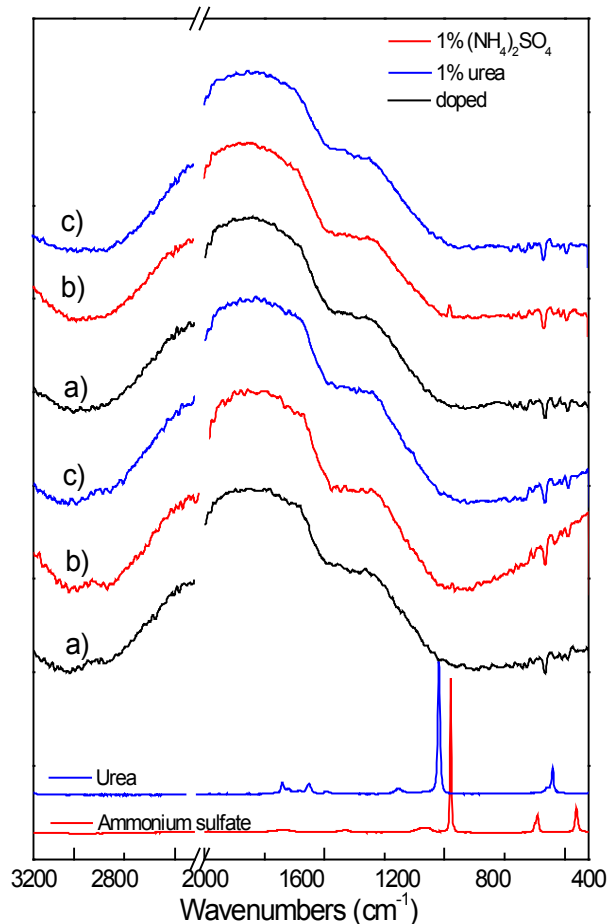

**Figure 9.** FT Raman spectra of two compost fertilizers a) undoped; b) doped with 1% ammonium sulfate and c) doped with 1% urea.

example, do not have a  $\delta^{15}\text{N}$  value of less than 5, and values are typically greater. (The average  $\delta^{15}\text{N}$  value for unprocessed fish tissue in this study, based on literature and analyzed samples, is 11 with a standard deviation of  $\pm 3$ ; that of bat guano,  $8 \pm 3$ ; that of seabird guano,  $18 \pm 11$ ). A  $\delta^{15}\text{N}$  value of close to or lower than 5 in products derived from fish or guano alone suggests addition of synthetic nitrogen. Synthetic nitrogen has a  $\delta^{15}\text{N}$  value typically less than 5, and will therefore lower the overall value of the product, depending on how much is added. This guideline does not apply to products containing soybean meal, which has a  $\delta^{15}\text{N}$  value naturally close to zero. Certain seaweeds and algae can also have a value near but not less than zero; the threshold value of 5 is not applicable to products formulated with seaweed or algae. Based on the samples obtained for analysis, other materials, such as feather meal, “humic acids”, and blood meal, may have  $\delta^{15}\text{N}$  values less than 5, but only slightly. In general, any sample with a value less than zero, excluding soybean meal and Chile nitrate (another

exception), may be suspected of adulteration.

**Step 5.** When a sample clearly falls outside of these values, adulteration is almost certain and the source of the sample may be duly investigated. However, other samples, depending on the degree of adulteration, may have values which tend toward the threshold values compared to other samples, but are not conclusive by themselves. In such cases, more than one analysis should be used. If two or three of the above analyses each give values that approach their respective threshold values, a sample may be suspected with greater confidence than just one uncertain result.

The protocol below shows the summary of the systematic analyses to be completed when investigating the potential adulteration of an organic fertilizer (**Figure 10**).

## ACKNOWLEDGEMENTS

Additional support for this project is provided by the Organic Trade Organization.

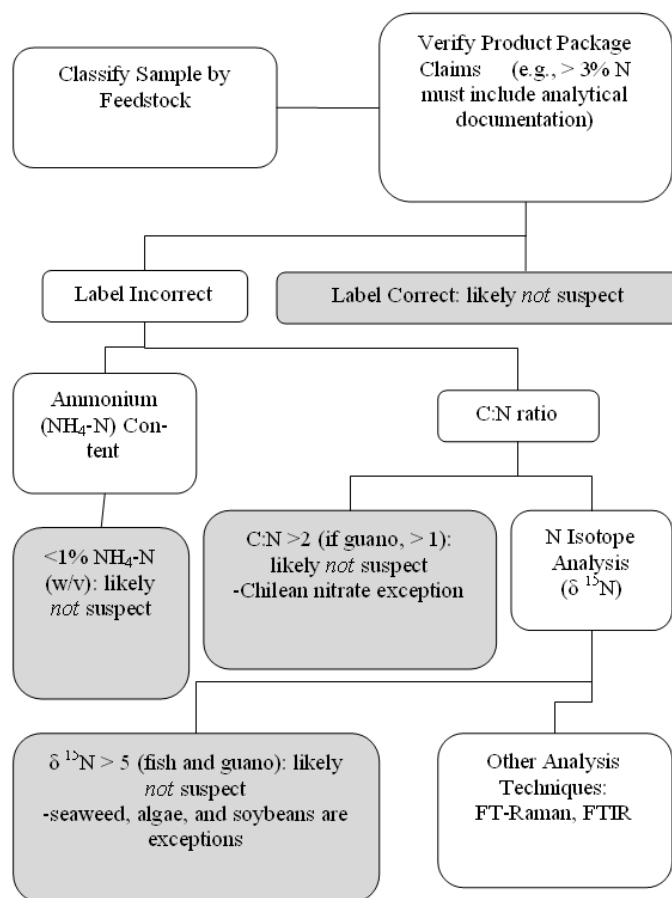

**Figure 10.** Flow chart showing the tests in the protocol to determine the potential adulteration of organic fertilizers

# Assessment of Plant Fertility and Fertilizer Requirements for Agricultural Crops in California

PROJECT LEADER  
**William R. Horwath**  
Professor of Soil  
Biogeochemistry  
Department of Land, Air &  
Water Resources  
University of California  
Davis, CA, 95616  
(530) 754-6029  
wrhorwath@ucdavis.edu

CO-PROJECT LEADER  
**Daniel Geisseler**  
Post doctoral scientist  
Department of Land, Air &  
Water Resources  
University of California  
Davis, CA, 95616  
(530) 754-6497  
djgeisseler@ucdavis.edu

## INTRODUCTION

The present project is a collaborative effort between the Department of Land, Air and Water Resources at the University of California, Davis and the California Department of Food and Agriculture Fertilizer Research and Education Program (FREP). In order to make findings of the approximately 160 projects funded by FREP over the past 20 years available to growers and crop advisors, a web-based database platform is being developed.

## OBJECTIVES

The overall objective of the project is to make technical research data and findings, collected over the past 20 years through FREP-funded projects, readily available to growers and crop advisors through a user-friendly, web-based, database. The following are specific objectives:

1. Synthesizing full technical reports for crop/plant nutrient and water requirements, etc.
2. Assisting CDFA IT to develop the database.
3. Researching additional data for each report needed for databases (e.g., soil type using NRCS soil survey database).
4. Provide a concise written summary for each technical final report.
5. Write final report with major conclusions and future directions for research.

## DESCRIPTION OF ACCOMPLISHMENTS AND ACTIVITIES

In a first step, a template of the database has been created in collaboration with CDFA-IT. Key information from final reports is entered into specific fields, such

as Project Title, Project Number, Crop, Start Year, End Year, County, Location, Project Leaders, Cooperators, Supporters, Project Highlights, Introduction, Methods/Management, Findings, or Outreach Activities.

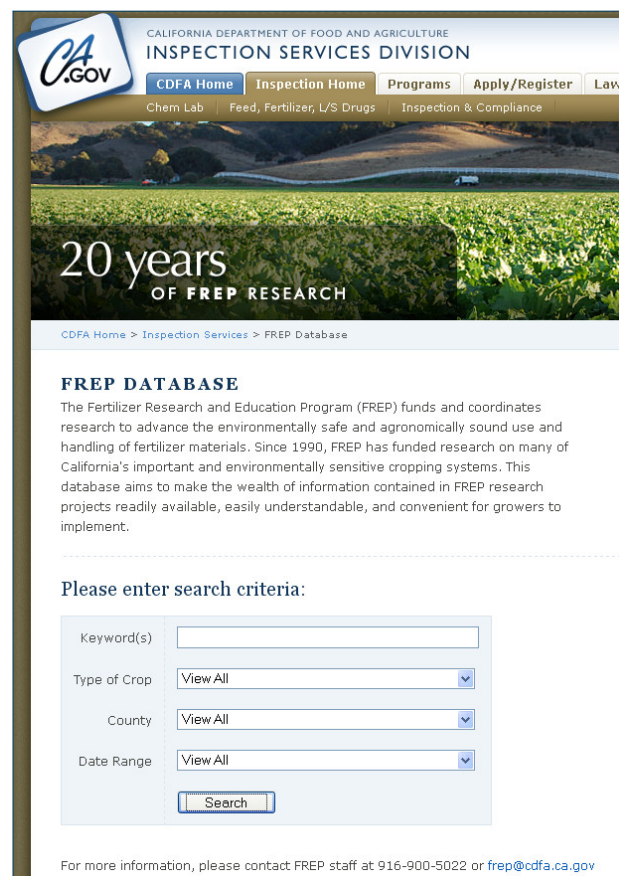

The screenshot shows the website for the California Department of Food and Agriculture (CDFA) Inspection Services Division. The page features a navigation menu with links for CDFA Home, Inspection Home, Programs, Apply/Register, and Law. Below the navigation is a banner for "20 years OF FREP RESEARCH" with a background image of a green field. The main content area is titled "FREP DATABASE" and includes a search form with fields for Keyword(s), Type of Crop, County, and Date Range, each with a "View All" dropdown menu. A "Search" button is located below the form. The page also includes a breadcrumb trail: CDFA Home > Inspection Services > FREP Database. At the bottom, there is contact information for FREP staff.

**Figure 1.** Start site allowing the user to enter search criteria (online at <http://www.cdfa.ca.gov/is/frep/Default.aspx>).



In a second step, a website is currently being constructed which allows searching for specific projects using different search criteria. The projects include the entire history of all funded FREP projects since 1992. Users can access reports as follows:

- On the start page, users can search for specific topics by either entering a keyword or choosing a crop type, a county, or a data range from a drop-down menu (**Figure 1**).
- After clicking on “Search”, the projects matching the search criteria are listed. The list includes project titles, counties, and crop types (**Figure 2**).
- By choosing a specific project, users can access a summary of the project. The summary includes the project title, principal investigators, highlights, introduction, a description of the methods used and the major findings of the study. (**Figure 3**).

**FREP DATABASE**  
Search results:

Study Title	Project County	Crop Type
Air Quality and Fertilization Practices: Establishing a Calendar of Nitrogen Fertilizer Application Timing Practices for Major Crops in the San Joaquin Valley	Kern, Tulare, Kings, Fresno, Madera, Merced, San Joaquin, Stanislaus	Alfalfa, Almond, Corn, Cotton, Wheat
Ammonia Emission Related to Nitrogen Fertilizer Application Practices	Fresno	Alfalfa, Almond, Barley, Citrus, Corn, Cotton, Grape, Pasture, Tomato, Turf, Walnut
Can We Predict K Fixation in the San Joaquin Valley from Soil Texture and Mineralogy?	Fresno, Kings, Tulare, Kern	Cotton
Establishing Updated Guidelines for Cotton Nutrition	Merced, Madera, Fresno, Tulare, Kings, Kern	Cotton
Fertilization Technologies for Conservation Tillage Production Systems in California	Yolo, Fresno	Tomato, Corn, Cotton
Interaction of Cotton Nitrogen Fertility Practices and Cotton Aphid Population Dynamics in California Cotton	Tulare, Fresno, Kings, Kern, Merced, Madera	Cotton
Nitrogen Budget in California Cotton Cropping Systems	Kings, Fresno	Cotton
Residual Soil Nitrogen and Nitrogen Management for Acala Cotton	Kern, Tulare, Fresno	Cotton
Site-Specific Variable Rate Fertilizer Nitrogen Application in Cotton	Kings, Fresno	Cotton

**Figure 2.** Results of a database search for cotton-related projects (online at <http://www.cdca.ca.gov/is/frep/Default.aspx>).

**Figure 3.** Example of an online project summary (online at <http://www.cdca.ca.gov/is/frep/Default.aspx>).

**STUDY RECORD**

---

## Can We Predict K Fixation in the San Joaquin Valley from Soil Texture and Mineralogy?

*Pettygrove, G.S. and Southard, R.J., Department of Land, Air and Water Resources, University of California, Davis*

**Project Highlights**

- Soils formed in Sierra Nevada alluvium tend to fix K.
- Samples with exchangeable K levels of 50 ppm or less always fixed K, while samples with greater than 200 ppm exchangeable K did not fix K.
- Soils formed in Coastal Range alluvium do not fix K.

**Introduction**

Vermiculite is the soil mineral present in San Joaquin Valley soils that is responsible for making potassium (K) unavailable or less available to the cotton plant during flowering and boll fill. In spite of much research to relate this problem to field symptoms and to develop diagnostic criteria, no one has described the location of K-fixing soils.

**Methods/Management**

The objective of this research was to use information from digitized USDA country soil survey databases to map the location of soils in the San Joaquin Valley cotton production areas that potentially possess a high capacity to fix K in mineral interlayers. The study covered the cotton production areas of Fresno, Kings, Tulare, and Kern counties in the southern San Joaquin Valley. Potassium fixation was estimated on soil samples in the laboratory. Exchangeable K was determined with the standard ammonium acetate method.

**Findings**

Generally speaking there are two conditions that result in K fixation: weakly developed soils with high mica content (when derived from granitic parent materials) and intermediately developed soils having high vermiculite clay mineralogy. We were able to infer the potential for K fixation based on degree of soil development and other properties, which were extracted from a soils database using taxonomic criteria. The resulting map shows that the total area of potentially K-fixing soils is approximately 1.4 million acres. Soils formed in Coastal Range alluvium were found to not fix K, except to a small extent in deeper horizons. Soils formed in Sierra Nevada alluvium, however, do tend to fix K, especially in the subsurface horizons. The relationship between soil texture and K fixation was weak, due to the fact that vermiculite clay minerals were also found in the silt and fine sand fraction. Therefore, not only fine-textured soils may fix K. Samples with exchangeable K levels of 50 ppm or less always fixed K, while, no samples with greater than 200 ppm exchangeable K fixed K. We suggest that for cotton production, soils with exchangeable K values between 50 and 200 ppm and located within the area identified as potentially K fixing, a K fixation measurement should be considered.

**Crop**  
Cotton

**County**  
Fresno, Kings, Tulare, Kern

**Years of Study**  
2000 - 2002

**FREP Article**  
[Final Report](#)

[FREP Proceedings 2001: Page 75](#)

[FREP Proceedings 2002: Page 61](#)

[FREP Proceedings 2003: Page 107](#)

**External Links**  
[Pettygrove et al. 2011: Better Crops](#)

- In addition to the summary, the page also includes links to the final report, contributions to the FREP proceedings, and external links to sites closely related to the project, such as articles written by the project leaders that are available online.

The site went online on July 2<sup>nd</sup>, 2012 and can be accessed at <http://www.cdffa.ca.gov/is/frep/Default.aspx>.

In a third step, the data from different projects will be combined to create web-based fertilization guidelines for specific crops. The information will be complemented with data from the scientific literature. The guidelines include information about soil and tissue tests and their interpretation, as well as information about fertilizer rates, time of application, placement and types. They will also include a history of the development of fertilization practices leading to present best fertilization practices. In addition, this effort will attempt to incorporate future changes in agronomic management such as changes

in irrigation management and tillage. Cover crops will also be considered as a nutrient management approach. Fertilization guidelines are currently being written for cotton, which serves a model crop (Figure 4).

### SUMMARY

Approximately 160 projects have been funded by FREP over the past 20 years. The present project aims to make the data and results from these projects readily available to growers and crop advisors through a user-friendly, web-based, database. In collaboration with CDFA-IT, a database has been created and key information from final reports is being entered into the database. Furthermore, a website has been created which allows searching for specific projects using different search criteria. The website provides an overview for each project. Crop-specific fertilization guidelines shall further improve the accessibility of the data.

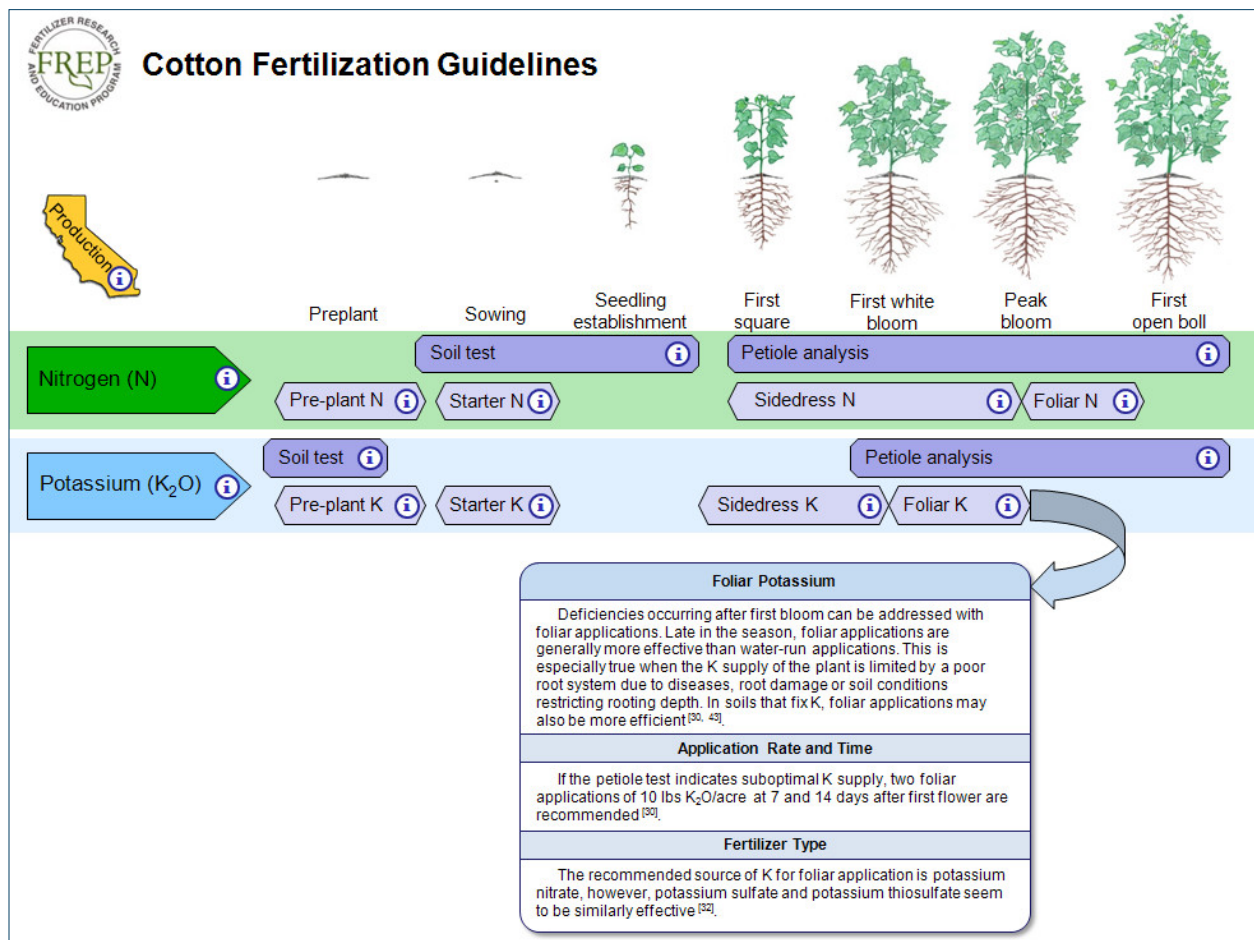

Figure 4. Screenshot of the page for cotton fertilization guidelines. By clicking on the different symbols, detailed information can be accessed, as was done in this example for foliar applications of potassium.

# Towards Development of Foliar Fertilization Strategies for Pistachio to Increase Total Yield and Nut Size and Protect the Environment: A Proof-of-Concept Project

## PROJECT LEADER

**Carol J. Lovatt**  
Professor of Plant Physiology  
Dept. of Botany and Plant  
Sciences  
University of California  
Riverside, CA 92521-0124  
(951) 827-4663  
carol.lovatt@ucr.edu

## PROJECT LEADER

**Robert H. Beede**  
UC Farm Advisor  
UCCE Kings County  
680 N. Campus Dr. Suite A  
Hanford, CA 93230  
(559) 582-3211  
bbeede@ucdavis.edu

## COOPERATOR

**Joseph C. MacIvaine**  
President  
Paramount Farming Company  
33141 E. Lerdo Highway  
Bakersfield, CA 93308-9767  
(661) 399-4456

## PISTACHIO ORCHARD

**Jason Haught**  
Ranch Manager  
Ranch 4140 Dudley Ridge  
13654 Highway 33  
Lost Hills, CA 93249  
(661) 797- 6540  
jasonh@paramountfarming.com

## INTRODUCTION

Foliar fertilization in crop production is encouraged. Replacing soil-applied fertilizer, at least in part, with foliar-applied fertilizer contributes to fertilizer best management practices (BMPs) by reducing the potential for accumulation of nutrients in soil, run-off water, surface water (streams, lakes and the ocean), and groundwater (drinking water supply), where they can contribute to salinity, eutrophication and nitrate contamination in the case of N, all of which have serious consequences on human health and the environment.

When successful, foliar fertilization provides the nutrients required for photosynthesis and other important metabolic functions directly to the leaves to prevent restrictions in carbon fixation, metabolism and plant productivity. Even a transient or incipient deficiency, needs to be corrected quickly. The longer the tree's nutrient status remains at the low end or below the optimal range at key stages of tree phenology, the greater the negative effects on the current year's yield and next year's bloom. Thus, foliar fertilization, which has the potential for being a rapid and efficient method for improving crop nutrient status during periods of high nutrient demand or when soil conditions render soil nutrients less available to the plant, could have a positive impact on yield.

For pistachio, potential yield benefits to be derived from foliar fertilization have yet to be fully realized. Like other deciduous fruit crops, pistachio reproductive growth commences prior to vegetative shoot extension and leaf expansion. Thus, foliar fertilization strategies at early stages of tree phenology by default target reproductive

structures, which are typically small. Despite this, bloom sprays of boron, zinc and urea applied to apple or pear increased fruit set and yield (Bajter and Thompson 1949, Righetti n.d., Stover et al. 1999). In the case of pistachio, boron applied in the late dormant stage (just prior to bud swell to 20% bud break) increased 3-year cumulative yield by 20% and reduced blanking as well as non-splits to further increase yield (Brown et al. 1995). The effect on yield of applying urea-N and zinc sprays (individually or in combination, including boron) to pistachio trees at this time remains to be determined. A further difficulty is that pistachio leaves, like those of many other crop plants, have a thick waxy cuticle known to compromise uptake of some foliar-applied nutrients once the leaves mature (Kallsen 2007). The following critical questions related to nutrient uptake by pistachio leaves remain unanswered. Can a sufficient amount of fertilizer be taken up when leaves are 2/3 expanded (and still have a thin cuticle) to provide a yield benefit? Will including urea as a "carrier" in the fertilizer spray sufficiently increase nutrient uptake by mature pistachio leaves to enhance yield?

## OBJECTIVES

The objective of our research is to obtain a positive effect on fruit set and yield, nut quality (increased percent split nuts, reduced percent aborted and blank nuts), and retention of floral buds for next year's crop with properly timed foliar fertilization. To meet this objective we are testing the capacity of the three foliar fertilization strategies discussed below to successfully supply key nutrients at phenological stages of high nutrient demand as well as application times reported to be efficacious

through previous research.

1. To test Strategy 1-The foliar application of boron (B), zinc (Zn) and urea (N) at bud swell to enhance flower nutrient levels (ovary and/or pollen) to increase fruit set. Despite uptake of only small amounts of nutrients, prebloom foliar applications of these elements have been shown to increase yield in other deciduous tree crops (Cowgill and Compton 1999, Jaganth and Lovatt 1998, Righetti n.d.). To date research into the response of pistachio trees to prebloom foliar-applied zinc have produced mixed results (Uriu 1986, Brown et al. 1994).
2. To test Strategy 2-The application of foliar fertilizers at 1/2- to 2/3-leaf expansion when leaves have a cuticle thin enough for nutrient uptake and sufficient surface area that the amount of nutrient taken up is large enough to enhance tree performance.
3. To test Strategy 3-The use of urea as a carrier to increase uptake of B, Zn, K and thiosulfate (S) into buds and/or leaves, especially during kernel filling when all but the most current pistachio leaves have a fully developed wax cuticle. Urea improved the uptake and efficacy of benzyladenine when hardened pistachio leaves were treated in June and July (Lovatt et. al. 2006). Researchers and growers report its use in foliar treatments (Righetti n.d.).
4. To calculate and disseminate a cost:benefit analysis to growers.

## DESCRIPTION

The design is a randomized complete block with 11 treatments (described under strategies 1 through 3 below), including an untreated control, and 15 individual tree replications of each treatment in a commercial orchard owned by Paramount Farming in Kings County. The 14-year-old 'Kerman' pistachio trees on Pioneer Gold 1 rootstock are planted in a row/tree spacing of 19 x 17 feet at 135 trees per acre. The experiment will be conducted for 2 years to determine treatment effects on yield and its components (nut size, split nuts, kernel weight, stained nuts, insect-damaged nuts, blank nuts) and on retention of floral buds for next year's crop. There are buffer trees between treated trees within a row and buffer rows between treated rows. At the specified stages of tree phenology, foliar fertilizers were applied in 100 gallons of water per acre (industry standard). Applications were made using a three-point fan sprayer producing strong canopy movement and fine droplet size. Sets of leaves in the four quadrants of the trees receiving fertilizer sprays were bagged just prior to fertilizer application and uncovered 4 hours later. Buds

were sampled prior to foliar applications. Buds and leaves, respectively, were collected 7 to 10 days after the fertilizer application for nutrient analysis. Leaves were also collected at the end of July (the standard time for leaf analysis) and in October to determine if increased leaf nutrient concentrations in response to foliar-applied fertilizers persisted at a level sufficient to "preload" the tree for the following spring bloom. Samples were immediately stored on ice, taken to UCR, washed, oven-dried at 60 °C, ground to 40-mesh, and sent to the UC-DANR Laboratory at UC-Davis for analysis. Tissues were analyzed for the following: N, S, P, K, Mg, Ca, Fe, Mn, B, Zn, and Cu by atomic absorption spectrometry and inductively coupled plasma atomic emission spectrometry. Additionally, one branch (bearing fruit) in each of the four quadrants of each treated tree was tagged and the initial number of floral buds per branch counted just prior to harvest. At harvest, individual tree yields were taken, and a 20-pound sample was submitted to Paramount Farming for quality assessment. Each year, treatment effects will be determined by ANOVA ( $P = 0.05$ ). After harvest in year 2, treatment effects on cumulative yield parameters will be determined ( $P = 0.05$ ). After harvest in year 2, a factorial analysis by year will be used to test for treatment effects on yield, and quality, floral bud retention and leaf nutrient concentrations. The alternate bearing index [ABI = (year 1 yield - year 2 yield) (year 1 yield + year 2 yield)] will also be calculated for each treatment. All data will be statistically analyzed using the General Linear Model procedure of SAS. A cost:benefit analysis will also be performed to determine the utility of the different foliar fertilizer strategies for pistachio production.

Fertilizer treatments to be tested in each strategy are the following:

1. Strategy 1 - the following treatments were applied at the bud swell to green tip stage of phenology: (1) N [6 lbs/acre, urea (46% N, 0.25% biuret)]; (2) N [6 lbs/acre, urea (46% N, 0.25% biuret)] combined with Zn [5 lb/acre, ZnSO<sub>4</sub> (36% Zn)] to test the capacity of urea to increase Zn uptake; (3) N [6 lbs/acre, urea (46% N, 0.25% biuret)], Zn [5 lb/acre, ZnSO<sub>4</sub> (36% Zn)] combined with B [5 lb/acre, Solubor (20.5% B)]; and (4) B [5 lb/acre, Solubor (20.5% B)]. We hope to determine whether using urea as a carrier provides any benefit in enhancing zinc and boron uptake.
2. Strategy 2 - the following treatments were applied at 1/2- to 2/3-leaf expansion: (1) Zn [2 lb/acre, ZnSO<sub>4</sub> (36% Zn)]; (2) N [6 lbs/acre, urea (46% N, 0.25% biuret)]; and (3) Zn [2 lb/acre, ZnSO<sub>4</sub> (36% Zn)] combined with N [6 lbs/acre, urea (46% N, 0.25% biuret)]. Comparison of treatment effects



will resolve whether urea increases Zn uptake and whether Zn and/or N increase fruit retention and yield.

3. Strategy 3 - the following treatments were applied in early June, early July and mid-August (application costs could potentially be reduced in the future by combining fertilizer with fungicide or navel orangeworm sprays): (1) K [10 lb/acre, KTS (0-0-25-17S)]; (2) K [10 lb/acre, KNO<sub>3</sub> (13-0-38)]; (3) N [6 lbs/acre, urea (46% N, 0.25% biuret)]; and (4) K [10 lb/acre, KTS (0-0-25-17S)] combined with N [6 lbs/acre, urea (46% N, 0.25% biuret)]. Comparison of treatment effects on yield will determine whether urea increases K uptake and whether trees need only K or benefit from added N and/or S at this time.

## RESULTS AND DISCUSSION

### Changes in Pistachio Tree Nutrient Status Over Time

To determine the effect of available soil nutrients on tree nutrient status over time, independent of the foliar fertilizer treatments, we plotted bud and leaf nutrient concentrations for each sampling date for the untreated control trees in this orchard (Figures 1 and 2). The orchard received 218.6 lbs N/acre - 17% in April, 33% in May, 25% in June and 25% in July. Leaf N peaked at the end of April, decreased ~1.5% by mid-June, and remained stable thereafter at approximately 2.5%. Applications of K (55.8 lbs/acre) and P (27.9 lbs/acre) were split - 14% in May, 43% in June and 43% in July. Leaf K increased from mid-June through the end of July at ~2.4%. Leaf P peaked at 0.43% in April and decreased to 0.14% or less from June through October. Calcium steadily increased from April through September. Magnesium

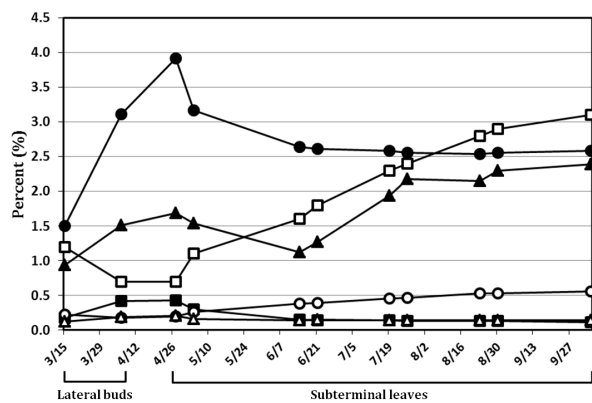

**Figure 1.** Changes with time in bud and leaf nutrient concentrations of untreated (control) 'Kerman' pistachio trees, Lost Hills, CA: (●) Nitrogen, (■) Phosphorus, (▲) Potassium, (□) Calcium, (○) Magnesium, and (△) Sulfur.

increased gradually over the entire growing season from 0.18% to 0.53%. Changes in the concentrations of N, P, K, Ca, Mg over time were equivalent to those reported by Brown and Siddiqui (2011). In addition, we report similar changes for S, B, Zn, Fe and Cu. From April 26 through October, leaf B steadily increased. Manganese steadily increased from March through mid-August. Iron decreased precipitously from March to late April, but thereafter increased somewhat erratically. Copper was highest in March (14.59 ppm), decreased to 8 ppm in June and remained just under 8 ppm through October. No B, Mn, Fe or Cu fertilizers were applied to the soil in this experiment. The nutrient content of leaves collected before and after foliar fertilizer treatment reflect these changes in pistachio tree nutrient status and must be considered when interpreting the data. Only the effects due to foliar fertilizer treatment are discussed herein.

### Effect of Foliar-Applied Fertilizers on Tissue Nutrient Concentrations.

#### Effect of fertilizer applications at bud swell to green tip.

At the start of the experiment, concentrations of N, P, K Ca, Mg, S, B, Zn, Mn, Fe, and Cu in flower buds collected at bud swell to green tip prior to the first fertilizer applications were not significantly different among trees in all treatments. This confirms that tree nutrient status was uniform for the data trees used in this research. Foliar application of B (alone) at the bud swell to green tip stage increased the bud concentration of B significantly. It must be noted that these buds were collected 19 days after treatment, whereas buds for the other treatments applied at this stage of development were collected only 8 days after treatment. This was because after the boron spray was applied, high winds prevented the application of urea-N, urea-N plus boron,

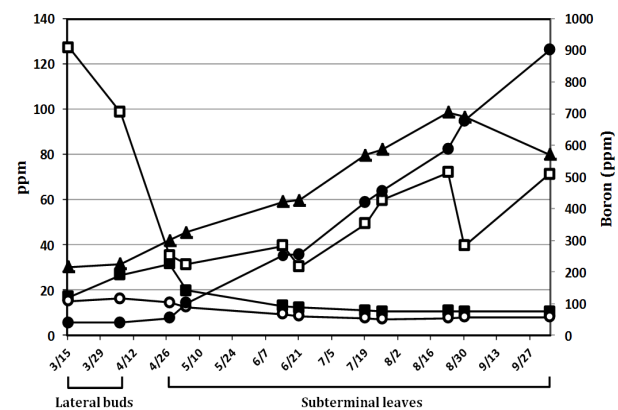

**Figure 2.** Changes with time in bud and leaf nutrient concentrations of untreated (control) 'Kerman' pistachio trees, Lost Hills, CA: (●) Boron, (■) Zinc, (▲) Manganese, (□) Iron, and (○) Copper.

and urea-N plus boron and zinc for 11 days and the buds in all treatments were collected 8 days later. Trees sprayed with B plus urea or B plus urea and Zn had significantly greater bud Zn concentrations than either the control trees or trees treated with urea alone. It is interesting to note that trees treated with B plus urea had the highest bud Zn concentration ( $P < 0.0001$ ) even though the trees did not receive Zn fertilizer.

**Effect of fertilizer applications at 1/2- to 2/3-leaf expansion.** Prior to foliar fertilizer application at 1/2- to 2/3-leaf expansion (LE), there were no significant differences in leaf concentrations of N, P, K, Ca, Mg, S, B, Zn, Mn, Fe, or Cu among fertilizer treatments. Leaf N concentration was significantly greater for trees receiving foliar-applied urea than for control trees. Trees sprayed with Zn or Zn plus urea had intermediate leaf N concentrations relative to the control. Applying Zn at LE did not increase leaf Zn concentration 10 days later.

**Effect of fertilizer applications in June, July and August.** Mid-June. Prior to the mid-June fertilizer applications, there were no significant differences in leaf nutrient concentrations among treatments. No significant changes in leaf nutrient status due to foliar fertilization were detected 7 days after application. Mid-July. Leaf samples collected prior to treatment in mid-July

showed that trees treated with KTS (+/- urea) in mid-June had significantly greater S concentrations than all other treatments ( $P < 0.0001$ ). Leaves collected after treatment showed that trees receiving KTS and KTS plus urea still had greater S concentrations than trees in all other treatments ( $P = 0.0004$ ). However, the treatment failed to increase leaf K. Mid-August. Leaves sampled pre-treatment in mid-August showed that trees treated in mid-July with KTS had significantly greater S concentrations than trees in all other treatments ( $P < 0.0001$ ). These trees continued to have significantly greater concentrations of S after the mid-August fertilizer applications ( $P < 0.0029$ ). There were no other differences in leaf nutrient concentrations. Three foliar applications of KTS or  $KNO_3$  failed to increase leaf K or N in the case of  $KNO_3$ .

**Effect of foliar fertilizer applications on tree nutrient status in October.** Several foliar fertilizer treatments had a significant effect on tree nutrient status by the end of the season. Soil fertilizers also affected leaf nutrient concentrations by October. Nitrogen. Trees treated with urea in June, July and August had leaf N concentrations that were significantly greater than trees in all other treatments except trees receiving urea, urea + Zn, or Zn at leaf expansion and the control ( $P = 0.0113$ ) (Table

**Table 1.** Effects of canopy-applied fertilizers on leaf macronutrient concentrations of ‘Kerman’ pistachio trees in October.

Treatment	Application time	N	P	K	Ca	Mg	S
		%					
Urea-N	Bud swell to green tip	2.52 c <sup>2</sup>	0.115 a	2.43 a	3.1 ab	0.56 a	0.138 cd
Urea-N + B	Bud swell to green tip	2.51 c	0.116 a	2.46 a	3.0 abc	0.56 a	0.139 cd
Urea-N + B + Zn	Bud swell to green tip	2.54 bc	0.116 a	2.45 a	3.1 ab	0.58 a	0.138 cd
B	Bud swell to green tip	2.51 c	0.114 a	2.42 a	3.0 abc	0.55 a	0.137 cd
Zn	1/3 to 1/2 leaf expansion	2.57 abc	0.116 a	2.38 a	3.0 abc	0.55 a	0.140 cd
Urea-N	1/3 to 1/2 leaf expansion	2.62 ab	0.117 a	2.47 a	3.1 ab	0.56 a	0.141 cd
Zn + Urea-N	1/3 to 1/2 leaf expansion	2.56 abc	0.117 a	2.45 a	2.9 c	0.55 a	0.143 c
KTS	Jun, Jul, and Aug	2.50 c	0.115 a	2.41 a	3.0 abc	0.57 a	0.197 a
$KNO_3$	Jun, Jul, and Aug	2.52 c	0.115 a	2.50 a	3.1 ab	0.56 a	0.135 d
Urea-N	Jun, Jul, and Aug	2.65 a	0.117 a	2.43 a	3.1 a	0.57 a	0.142 cd
KTS + Urea-N	Jun and Jul	2.51 c	0.115 a	2.50 a	3.0 bc	0.55 a	0.178 b
Control		2.58 abc	0.117 a	2.39 a	3.1 ab	0.56 a	0.143 c
P-value		0.0113	0.8913	0.7306	0.0928	0.7410	<0.0001

<sup>2</sup> Values in a vertical column followed by different letters are significantly different at the specified P-value by Fisher’s Protected LSD Test.

1). Control trees had leaf N concentrations that were intermediate to and not significantly different from any treatment. Sulfur. Foliar-applied potassium thiosulfate (KTS) in June, July and August or KTS plus urea in June and July significantly increased leaf S concentrations relative to all other treatments ( $P < 0.0001$ ) (Table 1). Phosphorus, Potassium, Calcium and Magnesium. There were no significant differences in leaf P, K, Ca or Mg content among treatments by October (Table 1). Zinc. Trees treated with Zn alone or in combination with urea at leaf expansion had significantly greater leaf Zn concentrations than all other treatments ( $P < 0.0001$ ) (Table 2). Adding urea increased average leaf Zn over trees sprayed with Zn alone, suggesting that urea enhances Zn uptake at this stage of leaf development. A similar effect was not observed for urea plus Zn and B applied at bud swell to green tip. Boron, Manganese, Iron and Copper. There were no significant differences in leaf B, Mn, Fe or Cu content among treatments by October (Table 2).

#### Effect of Canopy Applications of Fertilizer on Bud Retention

Bud retention was low. By harvest only the apical bud remained on most shoots, with bud retention ranging from 1.1 to 1.3 per shoot. The fertilizer treatments had no effect on bud retention.

#### Effect of Canopy Applications of Fertilizer on Yield

No foliar fertilizer treatment significantly increased total dry weight of split nuts per tree. The foliar fertilizer treatments also had no effect on nut quality or kernel size (Table 3).

The experiment was well designed. No significant differences in the tissue concentrations of any nutrient existed among the trees prior to treatment until July. In July, trees treated with potassium thiosulfate (KTS) (+/- urea) in June had significantly greater leaf S concentrations prior to the second KTS application. Boron decreased in floral buds from 15 March to 6 April in the control trees. Canopy-applied B maintained the B concentration of buds at levels equal to or greater than the B concentration on 15 March and equal to or greater than the leaf B concentration of the untreated control trees on 6 April ( $P = 0.0191$ ). By October, leaves from all trees had equally high concentrations of B (821-1019 ppm), significantly above the suggested optimal range of 150 to 250 ppm (Beede 2004).

The standard time for collecting pistachio leaves for nutrient analysis is late July through mid-August. Analysis of leaves collected on 26 July indicated that Ca, S, Zn, Mn, Fe were all within the optimal range (Beede 2004). Leaf Mg ranged from 0.49% to 0.46% for the treatments. The critical value for Mg is presently 0.6%

(Beede 2004), but recent research by Brown and Siddiqui (2011) suggests that 0.45% is a more appropriate critical value. Phosphorus was at the low end of the optimal range to deficient. Leaf P ranged 0.146% to 0.137% (average leaf P was 0.137% for trees in two treatments); the critical value for P is 0.14%. Several nutrient concentrations exceeded their optimal range (the upper value of the optimal range is given in parentheses) (Beede, 2004): B (250) ranged from 452 ppm to 538 ppm; K (2.0%) ranged from 2.1% to 2.29% and N (2.5%) ranged from 2.53% to 2.62%.

By October, Zn alone applied at leaf expansion increased leaf Zn to a value significantly greater than trees in all other treatments except Zn + urea ( $P < 0.0001$ ). When Zn was applied with urea at leaf expansion, it further increased leaf Zn concentration to a value significantly greater than leaf Zn concentrations for trees in all treatments including trees treated with Zn alone ( $P < 0.0001$ ). This result provides clear evidence that urea facilitated the uptake of Zn at this application time. Trees receiving three foliar applications of potassium thiosulfate (KTS) in June, July and August or KTS combined with urea in June and July had significantly greater leaf S concentrations than other treatments 27 days after application that remained greater through October ( $P < 0.0001$ ). Both the KTS and  $\text{KNO}_3$  treatments failed to increase leaf K concentrations by October.

Single or multiple foliar applications of urea did not significantly increase leaf N concentrations 7 to 10 days after application but resulted in greater concentrations of N in leaves collected in October ( $P = 0.0113$ ). Three foliar urea applications were better than two. Interestingly, trees receiving three applications of  $\text{KNO}_3$  had very low leaf N concentrations by October, suggesting that mature pistachio leaves may absorb urea more efficiently. It was surprising that we significantly increased leaf N concentrations with foliar-urea given the amount of N applied to the soil for the season (218 lbs N/acre). All trees had tissue N concentrations between 2.47% and 2.65% through October. This level is on the high side of the current optimal range of 2.2-2.5% (Beede 2004).

#### ACCOMPLISHMENTS

Results from Year 1 of this research suggest that pistachio buds at the bud swell to green tip stage take up B as Solubor<sup>o</sup> and B and Zn (as  $\text{ZnSO}_4$ ) when combined with urea. The results are not confirmatory since the buds were not covered during fertilizer application. Consistent with this interpretation, leaf B concentrations in October were 100 ppm greater (not significant) for trees treated with B and urea than trees treated with B

**Table 2.** Effects of canopy-applied fertilizers on leaf micronutrient concentrations of ‘Kerman’ pistachio trees in October.

Treatment	Application time	B	Zn	Mn	Fe	Cu
		ppm				
Urea-N	Bud swell to green tip	953.3 a <sup>z</sup>	11.17 c	83.5 a	65.2 a	7.42 a
Urea-N + B	Bud swell to green tip	1019.1 a	11.13 c	80.9 a	61.3 a	6.91 a
Urea-N + B + Zn	Bud swell to green tip	996.3 a	10.39 c	78.0 a	61.9 a	6.87 a
B	Bud swell to green tip	912.2 a	9.92 c	84.8 a	58.0 a	7.32 a
Zn	1/3 to 1/2 leaf expansion	835.9 a	56.11 b	86.1 a	65.4 a	7.45 a
Urea-N	1/3 to 1/2 leaf expansion	888.5 a	10.17 c	80.2 a	57.3 a	7.31 a
Zn + Urea-N	1/3 to 1/2 leaf expansion	936.8 a	63.77 a	80.3 a	60.3 a	8.10 a
KTS	Jun, Jul, and Aug	876.1 a	10.64 c	79.6 a	55.6 a	7.67 a
KNO <sub>3</sub>	Jun, Jul, and Aug	821.0 a	10.30 c	80.4 a	63.2 a	7.31 a
Urea-N	Jun, Jul, and Aug	981.8 a	10.81 c	82.6 a	65.8 a	7.51 a
KTS + N	Jun and Jul	940.0 a	10.71 c	80.0 a	61.0 a	7.28 a
Control		901.0 a	10.59 c	80.1 a	71.3 a	8.09 a
<i>P</i> -value		0.8002	<0.0001	0.9283	0.7808	0.9471

<sup>z</sup> Values in a vertical column followed by different letters are significantly different at the specified *P*-value by Fisher’s Protected LSD Test.

**Table 3.** Effects of canopy-applied fertilizers on yield and nut quality of ‘Kerman’ pistachio, Lost Hills, CA. Harvest was 22 August 2011.

Treatment	Application time	Split nut dry wt.	Blank nuts	Dark stained nuts	Insect damage	Embryo dry wt.
		kg/tree		%		mg/nut
Urea-N	Bud swell to Green tip	17.9 a	3.5 a	1.0 a	0.2 a	734 a
Urea-N +B	Bud swell to Green tip	19.5 a	3.1 a	1.0 a	0.2 a	731 a
Urea-N +B + Zn	Bud swell to Green tip	19.4 a	2.8 a	1.2 a	0.2 a	715 a
B	Bud swell to Green tip	20.2 a	3.1 a	0.8 a	0.1 a	729 a
Zn	1/2 to 1/3 leaf expansion	20.7 a	3.4 a	1.0 a	0.1 a	719 a
Urea-N	1/2 to 1/3 leaf expansion	19.8 a	2.9 a	1.3 a	0.1 a	714 a
Zn+ Urea-N	1/2 to 1/3 leaf expansion	18.9 a	3.5 a	1.0 a	0.2 a	722 a
KTS	June, July & August	20.5 a	3.4 a	1.1 a	0.2 a	721 a
KNO <sub>3</sub>	June, July & August	19.4 a	3.2 a	0.9 a	0.1 a	733 a
Urea-N	June, July & August	19.0 a	3.5 a	1.3 a	0.1 a	722 a
KTS+ Urea-N	June & July	19.2 a	2.8 a	1.5 a	0.1 a	734 a
Control		19.6 a	3.1 a	0.8 a	0.1 a	726 a
<i>P</i> -value		0.3026	0.4731	0.7214	0.6992	0.5804

<sup>z</sup> Values in a vertical column followed by different letters are significantly different at the specified *P*-value by Fisher’s Protected LSD Test.



only at bud swell to green tip. In most cases, increases in leaf nutrient concentrations were not detected in leaves that had been covered prior to application and collected for analysis 7 to 10 days later. However, nutrient analysis of leaves collected in October provided clear evidence that several foliar-applied fertilizers had increased tree nutrient status. October leaf analyses demonstrated that Zn (as ZnSO<sub>4</sub>) applied at LE was absorbed and that urea increased the Zn uptake at this time. October leaf S concentrations were significantly increased by three applications of KTS or two applications of KTS combined with urea compared to all other treatments; however, the desired effect of increasing tree K status was not achieved. Trees that received three applications of urea (June, July and August) had the highest October leaf N concentrations, but not significantly greater than the control trees or trees receiving a single application of urea at leaf expansion. Although our research results demonstrated the successful uptake of foliar-applied fertilizers, no yield benefit was obtained.

## ACKNOWLEDGEMENTS

This research was supported in part by the California Department of Food and Agriculture Fertilizer Research and Education Program and the Univ. of California, Riverside Citrus Research Center and Agricultural Experiment Station. The authors thank Paramount

## LITERATURE CITED

- Albrigo, L. G. 1999. Effects of foliar applications of urea or Nutri-Phite on flowering and yields of Valencia orange trees. *Proceedings of the Florida State Horticultural Society* 112:1-4.
- Bajter, L.P. and A.H. Thompson. 1949. Effect of boric acid sprays during bloom upon the set of pear fruits. *Proceedings of the American Society of Horticultural Science* 53:141-142.
- Beede, R.H. 2004. [http://fruitsandnuts.ucdavis.edu/pistachio/pages/pistachio\\_nutrients\\_fertilization/](http://fruitsandnuts.ucdavis.edu/pistachio/pages/pistachio_nutrients_fertilization/)
- Boman, B.J. 2002. KNO<sub>3</sub> foliar application to 'Sunburst' tangerine. *Proc. Fla. State. Hort. Soc.* 115:6-9.
- Brown, P.H., L. Ferguson and G. Picchioni. 1995. Boron boosts pistachio yields. *Fluid Journal* 3:11-13.
- Brown, P.H. and I. Saddiqui. 2011. Development of leaf sampling and interpretation methods for pistachio and development of a nutrient budget approach to fertilizer management in pistachio. Annual Report-2011, California Pistachio Research Board.
- Brown, P.H., Q. Zhang, and B. Beede. 1994. Effect of foliar fertilization on zinc nutritional status of pistachio trees. *Calif. Pistachio Ind. Ann. Rpt.* 1993-94:77-80.
- Chaplin, M.H., R.L. Stebbins, and M.N. Westwood. 1977. Effect of fall-applied boron sprays on fruit set and yield of Italian prune. *HortScience* 12:500-501.
- Cowgill, W. and J. Compton. 1999. Foliar nutrient suggestions on apples and peaches. *Rutgers Coop. Exten. Plant & Pest Advisory Fruit Ed.* 3(3):3.
- Jaganath, I., Lovatt, C.J. 1998. Efficacy studies on pre-bloom canopy applications of boron and/or urea to 'Hass' avocado. *Acta Hort.* 1:181-184.
- Kallsen, C. (2007). Pistachio notes. University of California Cooperative Extension March 2007, p.1-3.
- Lovatt, C. J. 1999. Timing citrus and avocado foliar nutrient applications to increase fruit set and size. *HorTechnology* 9:607-612.
- Lovatt, C.J., H. Daoudi, L. Ferguson. 2006. Foliar-applied cytokinins and nitrogen reduce alternate bearing and increase cumulative yield of pistachio. *Acta Horticulturae* 727:353-364.
- Righetti, T.K. n.d. <http://www.borax.com/agriculture/files/an102.pdf>
- Stover, E., M. Fargione, R. Risio, W. Stiles, and K. Iungerman. 1999. Prebloom foliar boron, zinc and urea applications enhance cropping of some 'Empire' and 'McIntosh' apple orchards in New York. *HortScience* 34:210.
- Uriu, K. 1986. Zinc deficiency in pistachio, diagnosis and correction. California Pistachio Industry, 1986 Annual Report

# Survey of Nitrogen Uptake and Applied Irrigation Water In Broccoli, Cauliflower and Cabbage Production in the Salinas Valley

## PROJECT LEADER

**Richard Smith**  
UCCE Vegetable Crops Farm  
Advisor  
Monterey, San Benito and  
Santa Cruz Counties  
1432 Abbott Street  
Salinas, CA 93901  
(831) 759-7357  
rifsmith@ucdavis.edu

## PROJECT LEADER

**Mike Cahn**  
UCCE Irrigation Farm Advisor  
Monterey, San Benito and  
Santa Cruz Counties  
1432 Abbott Street  
Salinas, CA 93901  
(831) 759-7377  
mdcahn@ucdavis.edu

## PROJECT LEADER

**T.K. Hartz**  
Extension Specialist  
Department of Plant Sciences  
University of California  
1 Shields Ave.  
Davis, CA 95616  
(530) 752-1738  
tkhartz@ucdavis.edu

## INTRODUCTION

Vegetable production on the Central Coast is dominated by cool season vegetables. The N uptake pattern of lettuce, which has the most acreage in this region, has been examined in numerous studies over the past 15 years. The information provided by these studies has proven useful for this industry to respond to regulations proposed by the Central Coast Regional Water Quality Control Board (CCRWQCB) to regulate N application. However, other crops that have significant acreage and value on the Central Coast include broccoli, cauliflower and cabbage but have not received the same level of attention because they do not have commodity board support. These crops also play an important role in achieving water quality goals set by the CCWQCB.

The overall goal of this project is to provide detailed measurements of total N uptake and the N uptake pattern of broccoli, cauliflower and cabbage. Total applied N is critical to crop production, but irrigation efficiency is critical to maintaining nitrate in the root zone. This project is evaluating irrigation management of these crops in comparison with their water requirements to identify potential practices that may reduce nitrate leaching losses. Together, this information will provide the basic information necessary for growers to better manage nitrogen inputs to these crops and safeguard water quality.

## OBJECTIVES

1. Evaluate N uptake, water application and rooting depth of broccoli, cauliflower and cabbage
2. Extend the findings of this research to growers

on the Central Coast to increase understanding of N uptake and publish results to provide documentation of the findings

## DESCRIPTION

A survey of well-managed, high-yielding broccoli, cauliflower and cabbage fields is being conducted in Monterey, Santa Cruz, San Benito and Santa Clara Counties. Evaluations include nitrogen uptake during the cropping cycle. Survey fields utilize typical production practices for this region as well as new production practices (i.e. five-line 80 inch bed broccoli, three-line 80 inch bed cauliflower and transplanted broccoli); irrigation and fertilization practices of selected fields will also be typical of the region (i.e. sprinkler and drip irrigation). Fields were selected that encompass the range of microclimatic factors close to the coast and inland. Evaluations will be conducted on 18 commercial fields (six of each commodity) in 2012 and 2013 production seasons (36 total fields). Crop biomass, biomass N and soil nitrate-N will be measured three to four times during the growing season to measure the N uptake pattern and total N uptake. At harvest, total biomass and commercially harvested biomass and biomass N will both be measured. Also at harvest, total crop biomass will also be analyzed for phosphorus and potassium. Fertilizer application rates and timing in each field will also be documented.

Rooting depth was characterized at weekly intervals during plant establishment and then bimonthly intervals until harvest. Flow meters were installed at each monitored field to quantify the volume of water applied from crop establishment to harvest. The flow

meters were connected to data loggers to record the length and frequency of irrigations. Infra-red canopy photos were taken every 2 weeks to develop crop coefficients for estimating crop ET. Soil moisture sensors were also installed to monitor changes in soil moisture storage. Using these data, we will be able to estimate the volume of drainage below the root zone. In a subset of fields, soil moisture was monitored at 8 and 18 inch depths using watermark sensors.

This project is in its first year and the results reported in this report are of one field of broccoli that was transplanted on March 22, 2012. Field configuration was five line 80 inch beds with 42,323 plants per acre. This is a relatively new production configuration for broccoli, but may reflect a trend towards higher intensity production.

## RESULTS AND DISCUSSION

**Table 1** shows fresh and dry biomass accumulation over the course of the growth cycle. The highest net accumulation of biomass and nitrogen uptake occurred from 56 to 77 days after transplanting (DAT). During these eleven days biomass accumulation increased at 1.87 tons fresh biomass/day and nitrogen uptake occurred at 12.0 lbs N/A. At harvest total broccoli biomass contained 301.9 lbs N/A. This amount is higher than previously reported values of total nitrogen uptake. Of the biomass accumulation 18.7% was in the harvested heads, 66.3% in the leaves and 14.9% in the stalks. Roots represented only 4% of the total above ground biomass.

Broccoli leaf canopy cover (**Figure 1**) reached maximum size (98%) approximately 60 days after transplanting. Roots reached a depth of 2 feet (**Figure 2**) during the same period, and continued growing, reaching more than 2.5 feet by 80 DAT. Soil moisture data (not presented) confirmed that roots were actively removing moisture below 18 inches 50 DAT. The field received a total of 20.2 inches of water through overhead sprinklers and an additional 6.5 inches through rainfall (**Figure 3**) during the season. Estimated crop evapotranspiration was 10.9 inches during this period; therefore a substantial volume of water likely percolated below the root zone. One reason that a significant volume of drainage occurred was that applied water averaged 2.0 inches per irrigation event, which exceeded the water holding capacity of the soil.

**Table 1.** Biomass accumulation and nitrogen uptake by broccoli on five evaluation dates

Yield Component	April 17 26 DAT <sup>1</sup>	May 1 39 DAT	May 18 56 DAT	June 7 77 DAT	June 14 84 DAT
Fresh Biomass T/A	0.29	3.72	16.65	37.21	47.83
Dry biomass T/A	0.04	0.43	1.83	3.86	4.56
Lbs N uptake	4.20	44.52	143.11	276.09	301.85
% N in tissue	4.80	5.22	3.85	3.65	na

<sup>1</sup> - DAT = Days after transplanting

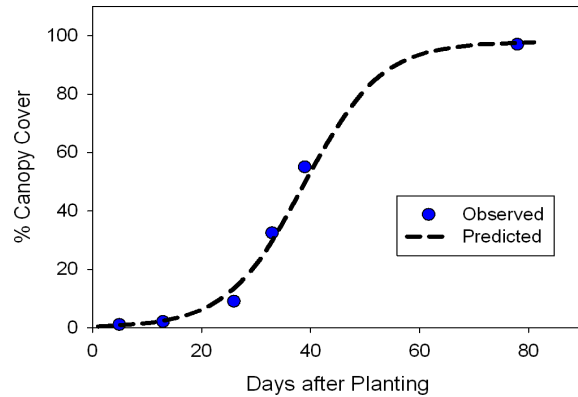

**Figure 1.** Observed and predicted canopy cover for 5 row transplanted broccoli on 80 inch wide beds.

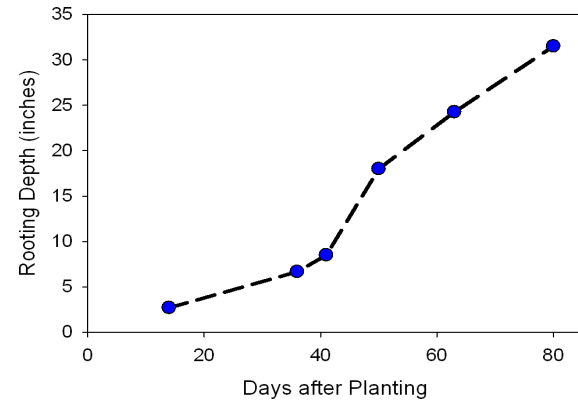

**Figure 2.** Observed rooting depth of 5 row transplanted broccoli on 80 inch wide beds.

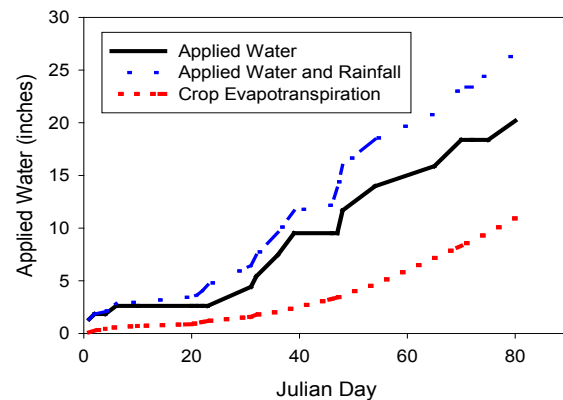

**Figure 3.** Applied water, rainfall, and estimated crop ET for 5 row transplanted broccoli on 80 inch wide beds.











# Development of Leaf Sampling and Interpretation Methods for Almond and Pistachio

## PROJECT LEADER

**Patrick Brown**  
Professor  
Department of Plant Sciences  
University of California,  
One Shields Ave  
Davis, CA 95616-8683  
(530) 304-1390  
pbbrown@ucdavis.edu

## COOPERATOR

**Sebastian Saa**  
PhD Candidate  
Department of Plant Sciences  
University of California  
One Shields Ave  
Davis, CA 95616-8683  
(530) 219-2137  
ssaasilva@ucdavis.edu

## COOPERATOR

**Bruce Lampinen**  
Professor  
Department of Plant Sciences  
University of California  
One Shields Ave  
Davis, CA 95616-8683  
(530)-752-2588  
bdlampinen@ucdavis.edu

## COOPERATOR

**Roger Duncan**  
Cooperative Extension  
University of California  
3800 Cornucopia Way  
Modesto, CA 95358  
(209) 525-6800  
raduncan@ucdavis.edu

## COOPERATOR

**Muhammad Ismail Siddiqui**  
PhD Candidate  
Department of Plant Sciences  
University of California  
One Shields Ave  
Davis, CA 95616-8683  
(530) 574 8146  
misiddiqui@ucdavis.edu

## COOPERATOR

**Richard Plant**  
Professor  
Department of Plant Sciences  
University of California  
One Shields Ave  
Davis, CA 95616-8683  
(530)-752-1705  
replant@ucdavis.edu

## COOPERATOR

**Blake Sanden**  
Farm advisor  
UCCE Tulare County  
University of California  
1031 S. Mt Vernon Ave  
Bakersfield, CA 93307  
(661) 868-6218  
Blсандen@ucdavis.edu

## INTRODUCTION

Results of a survey of almond growers, pistachio growers, and consultants in California, suggested that the existing leaf sampling protocol and comparison of the tissue results with the established standards does not provide sufficient guidance for nutrient management. Two explanations for this observation are possible:

1. The current critical values (CVs) are incorrect or not useful for the decision-making process due to lack of sensitivity or inappropriate timing.
2. There are systematic errors in the manner in which critical values are used.

While it is not known if UC CVs are incorrect (this will be verified), it is known that they have not been validated for early season use and it is clear that there has been a systematic error in the way leaf sampling and CVs have been used. We conclude that the 'problem' with current CVs is not that they are necessarily wrong, but that they do not account for within-field, within-canopy, between season or within-season variability. A vast majority of growers have also noted that the credibility of the current CVs have not been validated for early season fertilizer adjustments and many noted that even if a sound leaf sample is taken that the analysis cannot be used to

determine a specific fertilization response. Additionally, another constraint with current leaf sampling is that leaves are not collected until late July and frequently are not analyzed prior to fall. This late sampling provides the grower with no ability to make in-season fertilizer adjustments.

## SPECIFIC OBJECTIVES

Therefore, the aim of this research is to correct this situation by developing new approaches and interpretation tools that better quantify field and temporal variability, which are sensitive to yield and provide for in-season monitoring and fertilizer optimization in almond and pistachio across different locations. These projects also offer the unique opportunity to verify the current CVs and determine the utility of nutrient ratios as a diagnostic tool. Therefore, the integrated objectives of these research projects are to:

1. Determine the degree to which leaf nutrient status varies across a range of representative orchards and environments.
2. Determine the degree to which nutrient status varies within the canopy and within the year.
3. Validate early season leaf analysis protocols and relationship with yield, validate current CVs and

determine if nutrient ratio analysis provides useful information to optimize fertility management.

4. Test utility of use of fruiting spur leaf analysis under variable N and K treatments, validate as an indicator of tree nutrient status, monitor role of fruiting spur leaves in yield, monitor relationship between spur nutrient status and spur survival in almond.
5. Develop and extend an integrated nutrient BMP for almond and pistachio.

## PROJECT DESCRIPTION

A large-scale and long term survey of within-field, between-field, within-tree and between-organ nutrient concentration and variance is conducted in mature almond and pistachio orchards. The interaction between yield and nutrient status is being determined at 4 almond orchards (on >600 individual trees), and at 4 pistachio orchards (on >400 individual trees). All almond and pistachio trials have been initiated in 8 or 9 years old almond orchards and 10-15 year old pistachio orchards of good to excellent productivity planted to non-pareil (50%) and Kerman (97%) respectively. Both, almond and pistachio orchards are in soils representative of the major production regions.

The 4 experimental sites for almond project are located in Arbuckle, Modesto and Madera (2) and the 4 pistachio sites are located at Fresno County, Madera County, Kern County and Kings County. At 54 grid points uniformly distributed across a 10 acre block of trees, leaf nutrient status throughout the year (May through August) (N, P, K, S, Ca, Mg, B, Zn, Fe, Mn, Cu), light interception, trunk diameter and tree yield are being determined in each tree. Further, in almond trees, three different kinds of leaves and nut samples are being collected at 5 times during the growing season to explore different sampling methods. Similarly, in pistachio trees, leaf and nut samples were collected at various times throughout the season (2009-2011) to determine the degree of variability in tissue nutrient concentrations

over time, space and within tree canopies to validate the established standards and develop nutrient budget models for important major nutrients. To validate our existing project results, sample collection is continuing over the growing season in 2012. All tissues that are collected are being analyzed for nutrient concentration of N, P, K, Ca, S, Mg, B, Zn, Cu, Mn and Fe by standard methods at the Agriculture and Natural Resources (ANR) Laboratory at the University of California Davis.

## RESULTS AND DISCUSSION

### Almond

Leaf samples are characteristically collected in July in Almond. Collection of leaves earlier in the season would be useful for management by providing important information on current orchard nutrient status and providing adequate time to correct deficiencies if any. A major perceived source of nutrient variability in the leaves is attributed to rapid leaf growth early in the season. As leaves mature, nitrogen concentration decreases and other elements such as Ca increase. The standard July leaf nutrient sampling was historically selected because leaf growth has been completed and hence variability may be smaller. Evidence from this current trial suggests that this premise is not correct and that early season leaf analysis can be used for nutrient management purposes. Data collected in this study demonstrates that leaf-Ca-concentration is a good phenological tracker of leaf age and can be used to reduce variability (**Figure 1**).

Leaf sampling is only of value if enough samples are collected to adequately represent the nutrient status of the orchard as a whole. Based upon the three years of data analyses of moderately uniform and good producing orchards, we have derived a standard protocol required to effectively estimate July orchard nutrient status. This protocol is based upon grower standard practice of collecting only one sample per plot and has been validated for Nonpareil trees of greater than 8

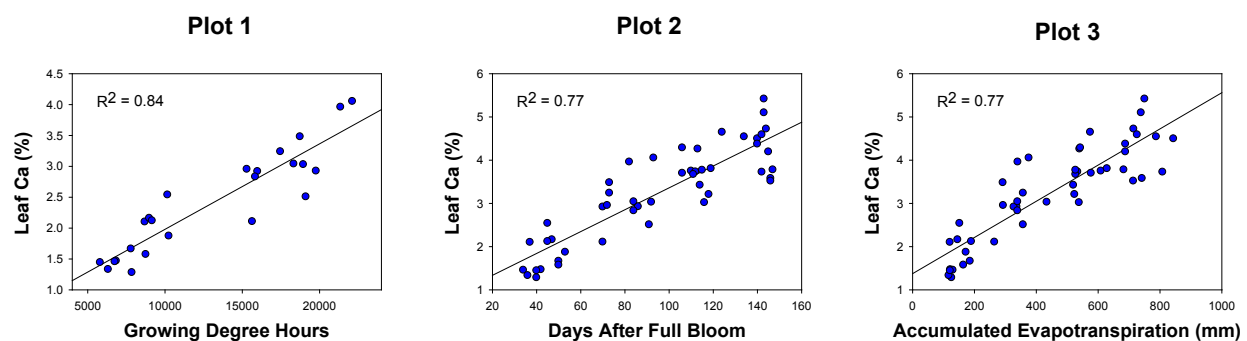

**Figure 1.** Regression plots validate the use of Ca as an indicator of leaf physiological age. Leaf Ca concentration is correlated with growing degree hours, (Plot 1), days after full bloom, (Plot 2) and accumulated evapotranspiration (Plot 3).



years of age. The following sampling strategy should be conducted independently in all orchard blocks. This is a minimum sampling strategy and improved management can be attained through the conduct of additional sample collections, especially in areas of lower productivity:

- Sample should be collected 6 weeks after full bloom
- Collect one sample if your orchard is uniform in terms of yield and avoid trees with obvious problems (i.e. sick trees).
- Collect multiple samples if areas of varied productivity are present.

Each Sample should be collected as follows:

- Collect leaves from 28 trees.
- Each sampled tree must be sampled at least 30 yards apart.
- In each tree collect leaves around the canopy from at least 8 well-exposed spurs located between 5-7 feet from the ground.
- Analyze samples for N, P, K, Ca, S, Mg, B, Zn, Cu, Mn and Fe.

A detailed analysis of data from four well-managed and visibly uniform sites over four years has allowed us to

estimate 'typical' field variability in Californian orchards of this type. Using these data it is possible to extrapolate from a well collected leaf sample to estimate the percentage of the field that will be above the established critical value of 2.2% N in July. This is shown in **Table 1**.

Using the data collected in this experiment we have developed five unique statistical models that allow for the prediction of July leaf N values from April sample collection dates. These models are currently being tested in six CA almond orchards and a validation is also being conducted by prominent soil testing labs in California.

### Pistachio

#### Model to predict July leaf nutrient status in pistachio.

Early season leaf sampling offers management advantages to growers allowing for in season adjustment. We predicted leaf nutrient (N/K/Ca) status of the trees in July as a function of other nutrients in May using multiple linear regression models (**Table 2**). This was performed for all four sites and for three seasons (July 2009, 2010 and 2011). The goal was to produce a model that works reasonably well for all sites and years, rather than one that needs to be calibrated to the characteristic of a particular site and year. Results suggest that, these models can be used to predict the nutrient status of the

**Table 1.** Relationship between July leaf tissue N concentrations in samples collected according to previously described sampling methods (this report) and percentage of trees in the orchard that will exceed the specified critical N value of 2.2%.

Relationship between July leaf tissue N concentration and percentage of the trees exceeding the critical value of 2.2%										
July N (%)	2.0	2.1	2.2	2.3	2.4	2.5	2.6	2.7	2.8	2.9
% of Trees Above 2.2%	6.6	22.6	50.0	77.4	93.4	98.8	99.9	100.0	100.0	100.0

**Table 2.** Measured Leaf N/K/Ca % in July contrasted with predicted values derived from May samples. Results represent data from the leaves on branches with no fruits from 54 trees in four research sites. Each individual leaf sample comprised of 10 fully expanded mature leaves collected from exposed non-fruiting branches at about 6 feet above the ground from around the tree canopy.

Site	County	Year	Real leaf N (%) July	Predicted leaf N (%) July	Real leaf K (%) July	Predicted leaf K (%) July	Real leaf Ca (%) July	Predicted leaf Ca (%) July
Paramount	Kings	2009	2.52	2.42	1.92	1.90	2.61	2.53
Paramount	Kings	2010	2.63	2.65	2.22	2.18	1.90	1.98
Paramount	Kings	2011	2.54	2.60	2.16	2.13	1.85	2.15
Buttonwillow	Kern	2009	2.74	2.62	2.38	1.94	2.73	2.70
Buttonwillow	Kern	2010	2.69	2.70	1.94	2.23	2.69	2.47
Buttonwillow	Kern	2011	2.78	2.71	2.28	2.04	2.07	2.29
Madera	Madera	2009	2.56	2.55	2.07	2.05	2.55	2.61
Madera	Madera	2010	2.46	2.53	1.75	1.98	2.11	2.11
Madera	Madera	2011	2.52	2.60	2.07	2.10	2.07	2.16
KammAvenue	Fresno	2009	2.82	2.67	2.14	2.06	2.95	2.73
KammAvenue	Fresno	2010	2.60	2.62	1.76	2.05	2.56	2.46
KammAvenue	Fresno	2011	2.49	2.63	2.00	2.11	2.52	2.41

trees in July. Validation of the existing model with the data from new sites is currently underway.

**Validation of current critical values (CV)**

**Magnesium (Mg).** The yield based relationship between yield and leaf Mg suggests that the critical values for Mg should be lowered to 0.45% (Figures 2A and 2B).

The data for (Mg) at Kings County (July, 2011) are consistent with the newly suggested CV value of 0.45% (Figure 2C).

**Nutrient Budget for pistachio.** The overall goal is to provide a guideline for the growers on the rate and timing of the application of major nutrients to the pistachio trees over the growing season. Seasonal nutrient removal curves were developed and are shown for NK and P in Figure 3 below. This information provides a baseline for all fertilization planning with the goal of growers to provide fertilization rates that replace nutrients removed in crop. Synchronizing nitrogen application with the tree demand can increase the nitrogen use efficiency and reduce the cost of N fertilizers and environmental hazards.

**FINDINGS**

**Almonds.** A model to predict July nitrogen content based on April Nutrient content has been generated for CA almond orchards. The model also predicts the percentage of trees that at July will have less than 2.2% of nitrogen. Calcium is a promising phenological tracking that seems to be essential to obtain unbiased and comparable results for leaf nutrient analysis. A yield model that integrates the current physiological knowledge and the current statistical techniques is on track and expected to be completed for next year.

**Pistachios.** The potential exists to predict nitrogen status of the pistachio trees in July based on May leaf samples. Results suggest that the CV for Mg should be lowered to 0.45%.

Pistachio yield varies between years and orchards and

hence the tree demand for the nutrients. Evidence suggests that considerable improvement in N use efficiency could occur with implementation of yield based fertilization programs.

**ACKNOWLEDGEMENTS**

We greatly appreciate the help and financial support from CDFA that enabled us to establish these nutrient optimization projects to develop the best management practices for almond and pistachio growers. We also highly appreciate Paramount and Agri-World for their great support

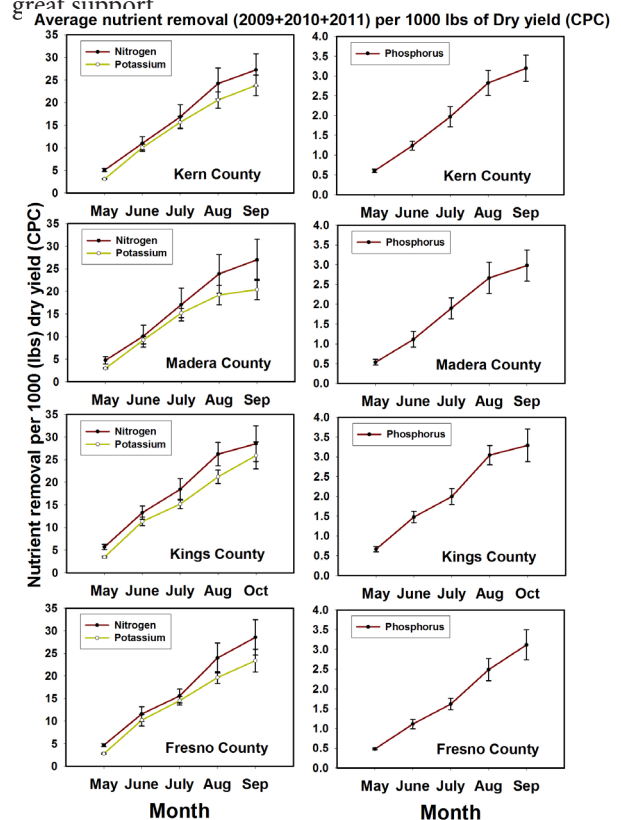

**Figure 3.** Average nutrient removal per 1000 lbs of dry yield (CPC) over the years (2009 + 2010+2011) at Kern, Kings and Fresno Counties. The data at Madera County represents average of two years (2009+2010). The CPC yield excludes (Hull weight and Blank nuts) and does include the split and non-split nuts.

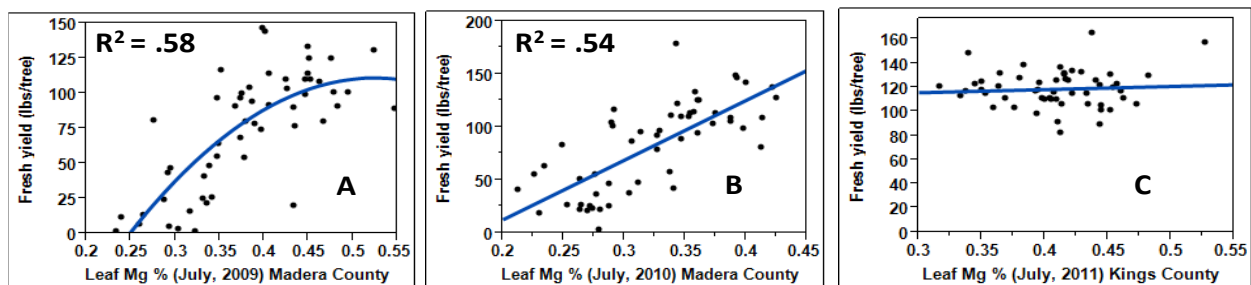

**Figure 2.** Relationship of leaf magnesium with the pistachio yield at Madera and Kings Counties. Figures (2A) and (2B) represent data from (July, 2009 and 2010) at Madera County respectively. Figure (2C) represents data from Kings County in July, 2011. Data represent values from 54 individual trees.

# Development of a Nutrient Budget Approach to Fertilizer Management in Almond

## PROJECT LEADER

**Patrick Brown**  
Professor  
Department of Plant Sciences  
University of California  
One Shields Avenue  
Davis, CA 95616  
(530) 752-0929  
phbrown@ucdavis.edu

## COOPERATOR

**Saiful Muhammad**  
PhD student  
Department of Plant Sciences  
University of California  
One Shields Avenue  
Davis, CA 95616  
(530) 752-8499  
smuhammad@ucdavis.edu

## COOPERATOR

**Blake Sanden**  
Irrigation & Agronomy Farm Advisor  
University of California  
Cooperative Extension  
1031 S. Mt Vernon Ave.  
Bakersfield, CA 93307  
(661) 868-6218  
blsanden@ucdavis.edu

## INTRODUCTION

There are many different approaches to nutrient management in crops that range from the simple to the sophisticated. Currently nutrient management in almond is based on the Critical Value concept (Brown and Uriu, 1996). Critical Value (CV) represents the leaf nutrient concentration of a standard leaf sample at which yield is equal to 90% of maximum yield. (Ullrich and Hills, 1990). Ideally, CVs are established in carefully controlled experiments, in which the relationship between yield and nutrient concentration is closely monitored. In almond the majority of CVs have been determined on the basis of visual symptoms, not based on yield reduction (Beutel et al., 1978; Brown and Uriu, 1996). Yield-based CVs in almond are only available for nitrogen (Uriu, 1976), potassium (Meyer, 1996; Reidel et al, 2004) and boron (Nyomora et al, 1999). Weinbaum (1990) suggested that a critical nitrogen leaf value of 2.3% in July non-fruiting spur leaves is likely adequate for almond.

In this approach leaf nutrient analysis provides only an indication of adequacy or deficiency but does not provide any specific information on the appropriate rate or timing of any fertilizer response. CVs are an insufficient approach to nutrient management in a high value species. Not only is the collection of a representative leaf sample difficult, and generally collected too late in the season to respond, our degree of confidence in the existing CVs is limited and most importantly the results provide no specific information on how to respond. An alternative approach that has been widely used in high value crops, uses knowledge of crop growth and development to derive nutrient demand curves that guide the quantity and timing of fertilizer applications. Nutrient budgets have been developed

for corn (Karlen et al 1988), cotton (Halevy et al 1977), tomato (Huett 1986) and others.

The mature almond tree is well suited to a budget approach to fertility management as it is relatively determinant in its growth patterns, almonds show limited vegetative re-growth after fruits reach full size, and the majority of whole tree macronutrient demand is partitioned to nuts. Once the leaves are fully mature, the N and K requirements for vegetation are largely satisfied. Fruits, on the other hand, continue to accumulate N and K until harvest.

## OBJECTIVES

1. Develop a phenology and yield based nutrient model for almond.
2. Develop fertilizer response curves to relate nutrient demand with fertilizer rate and nutrient use efficiency.
3. Determine the effectiveness and nutrient use efficiency of various commercially important N and K fertilizer sources.
4. Validate current CVs and determine if nutrient ratio analysis provides useful information to optimize fertility management.
5. Develop and extend an integrated nutrient BMP for almond.

## PROJECT DESCRIPTION

A large experimental fertilizer response trial was set up in an eight year old orchard in 2008, planted 50% to Non-Pareil and 50% to Monterrey almonds under Fan Jet and Drip irrigation systems. Fifteen individual trees

and their immediate 30 neighbors are considered as a single uniformly treated unit with all measurements taken on the central six Nonpareil trees individually. A total of 128 experimental units of 15 trees have been treated and from this 768 individual trees are being monitored for yield, nut growth and development and full nutrient status. A fertigation system has been installed and a digital flow meter has been employed to provide well controlled doses of fertilizer during four fertigation events. Basal sulphate of potash (SOP) application was made in early February and fertigation was done in February, April, June and October. The total experimental area is 100 acres.

The twelve treatments include 4 rates of N as UAN32, 4 contrasting rates of CAN17, 3 rates of K, and 3 sources of K as potassium chloride (KCl), SOP treatments and SOP+potassium thiosulphate (KTS). A zero N control (A-1) was introduced in fall 2011 by splitting the N rate 125lb/ac. Descriptions of the treatments are given in **Table 1**. Effectiveness of each treatment will be determined by changes in leaf tissue analysis, yield, and soil residual N and K over the course of the experiment.

Leaf samples were collected in April, May, June and July. Tissue determination for the major elements (N, P, K, S, Ca, Mg, B, Zn, Fe, Mn and Cu) in all the collected nut samples and leaf samples was processed by the DANR analytical laboratory at UC Davis. Tree yield and quality attributes were collected from 768 individual trees. All nutrient and biomass data will be cross-referenced to individual tree yield, phenology, environment and other variables to develop a phenology and yield based nutrient model for almond.

## RESULTS

### Nutrient Removal in Crop and Changes in Accumulation through the Season:

**Nitrogen.** Nitrogen accumulation in the fruit was influenced by nitrogen supply at all sampling dates. Trees suffering from an N limitation (125 and 200 lb/acre in this experiment) had reduced N concentration in leaves, kernels, shells and hulls. In all treatments and years about 80% of the total N accumulation in fruit had occurred by mid June (119 DAFB in 2011) as shown in **Figure 1**. In 2011, at harvest 54lb nitrogen was removed for each 1000lb kernel in the 125lb/ac nitrogen rate while 73 lb nitrogen was removed in fruit from N rate 275 lb/ac. The corresponding July leaf N concentration was 2.3% for 125lb/ac N rate and 2.8% for N rate 275lb/ac. The cooler spring and early summer in 2011 delayed fruit maturity and when the samples were collected in July there was no hull split while in the other years there were about 10% hull split when samples were collected in July. This may account for the higher N concentrations in leaves sampled in July these years. The nitrogen removal by 1000lb kernel yield slightly increased over the past three years 2009-2010 (2009 and 2010 data not shown) for the N rates 275lb/ac and 350lb/ac due to a slight increase in the fruit nitrogen concentration (data not shown).

**Phosphorus.** Phosphorus exhibited an annual trend that resembled nitrogen. By increasing nitrogen supply, fruit phosphorus removal declined slightly but not significantly. In 2011, 1000lb kernel yield removed 8.7lb phosphorus for N rate 125lb/ac while N rate 350lb/ac removed 8.3lb phosphorus to yield a 1000lb kernel

**Table 1.** Detail of fertilization treatments.

Treatment	N source	N amount (lbs/ac)	K source	K amount (lbs/ac)
A	UAN32	125	60% SOP / 40% KTS	200
B	UAN32	200	60% SOP / 40% KTS	200
C	UAN32	275	60% SOP / 40% KTS	200
D	UAN32	350	60% SOP / 40% KTS	200
E	CAN17	125	60% SOP / 40% KTS	200
F	CAN17	200	60% SOP / 40% KTS	200
G	CAN17	275	60% SOP / 40% KTS	200
H	CAN17	350	60% SOP / 40% KTS	200
I	UAN32	275	60% SOP / 40% KTS	100
J	UAN32	275	60% SOP / 40% KTS	300
K	UAN32	275	100% SOP	200
L	UAN32	275	100% KCl	200



(**Figure 1**). The decline in phosphorus removal with increasing nitrogen supply is due to the increase in kernel crackout from increased nitrogen supply, kernels were larger in high N treatments.

**Potassium.** Fruit potassium accumulation by 1000lb kernel increased linearly through the season. The effect of K rate on K accumulation is shown in **Figure 2**. In 2011, 1000lb kernel yield accumulated 67lb K per 1000 lb kernel at the 100lb K/ac rate and 78 lbs per 1000 lb kernel at the 300lb K/ac rate. The corresponding leaf K concentration in July was 1.5% and 2.3% for K rate 100lb/ac and 300lb/ac respectively. About 70% of the K was accumulated in the fruit by mid June (119 DAFB in 2011)

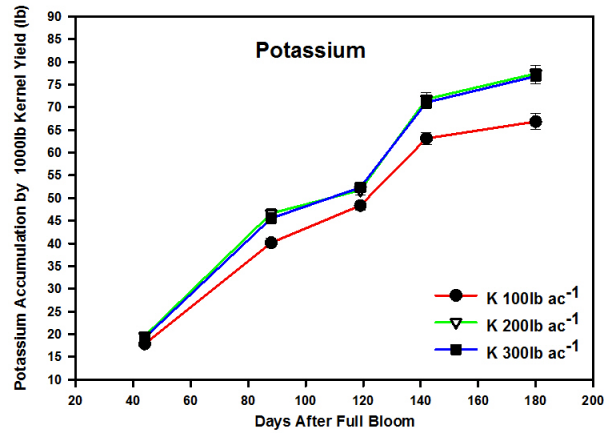

**Figure 2.** Potassium accumulation in almond fruit to produce 1000lb kernel yield from potassium rate treatments in 2011. Each point represents mean and std error.

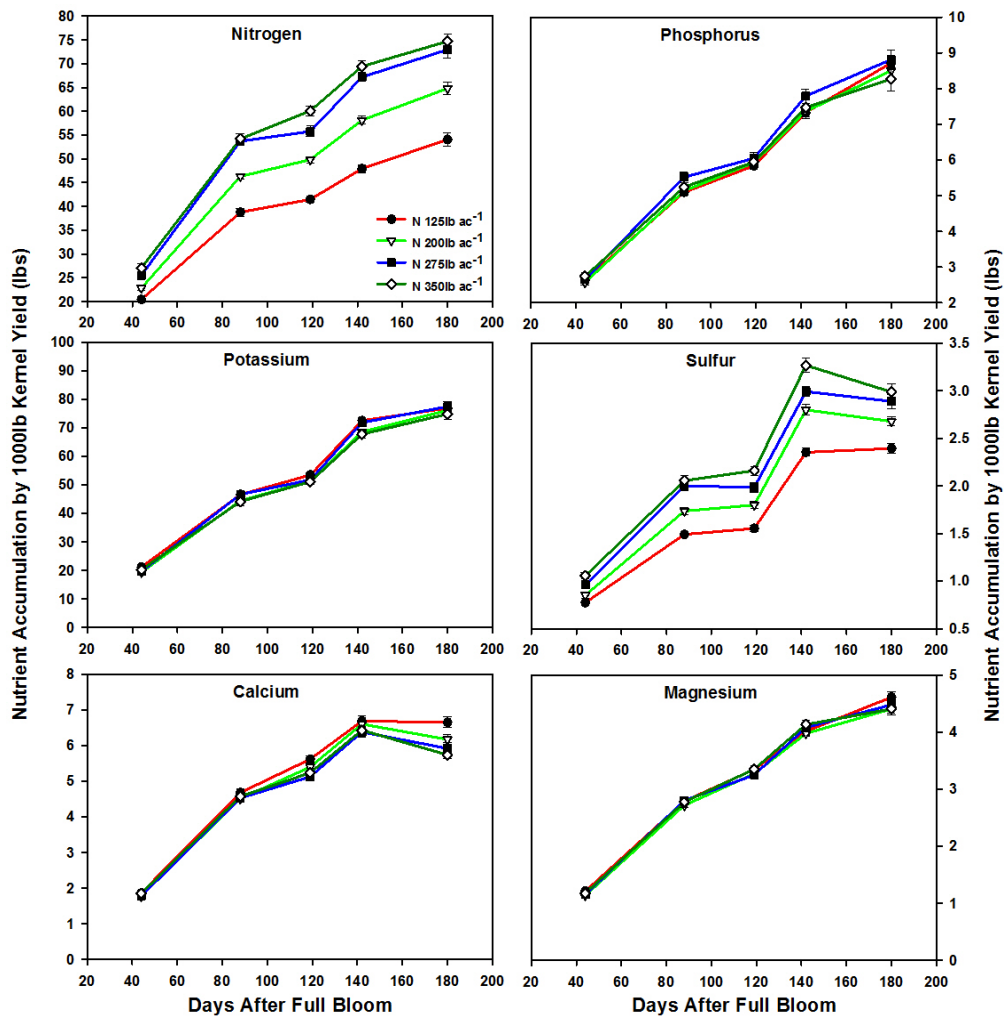

**Figure 1.** Nitrogen, Phosphorus, Potassium, Sulfur, Calcium and Magnesium removal by almond fruit to produce 1000lb kernel yield from nitrogen rate treatments in 2011. Each point represents mean and standard error.

## Yield

Nitrogen treatments had a significant effect on crop yields in all the four years of the experiment. The effect of nitrogen rate and source on kernel yield in 2011 is shown in **Table 2**. Maximum kernel yield was obtained from the N rate treatment 275 lb ac<sup>-1</sup> and significant yield reduction was observed with lower nitrogen rate treatments (125 and 200lb ac<sup>-1</sup>). Increasing nitrogen supply above 275 lbs acre did not increase yield but did result in reduced nitrogen use efficiency(NUE), defined here as N removed in harvested fruit divided by N supplied in fertilizers and water (**Table 4**). In these experiments we report an NUE from N rate 275lb/ac of over 88% which is remarkably high and reflects the precision with which N is managed in this setting. To address issues of the contribution of soil reserves to total plant N uptake we implemented a zero N treatment in 2011 and have been collecting intensive soil samples (data to be presented in 2013). Preliminary analysis suggests that trees treated with 125 and 200 lbs N are suffering from N deficiency (decreased tree size, leaf N). Trees receiving 125 lb N fertilizer treatments are depleting soil N reserves as indicated by diminishing soil N and organic matter in the surface layers. No significant effect of N sources has been observed on kernel yield. Preliminary data collected from tree perennial organs over time suggests that tree treated with 125lb per acre N are depleting plant N reserves to support fruit production.

Despite significant decreases in tissue K concentrations (<1.5% in the 100 lb/ac K rate) no significant differences in yield have been observed for K rate treatments (**Table 3**). K sources had shown a slight significant effect on yield under drip irrigation in 2010 (data not shown), however no significant effect was observed in 2011.

## DISCUSSION

In the fourth year of the experiment treatments show an increasing effect on tissue nutrient concentration, nutrient removal and yield. Increasing nitrogen supply significantly increased fruit yield and nitrogen concentration in the plant tissues and these differences existed between treatments at all sample dates. About 80% of the nitrogen and 70% of the potassium was accumulated in the fruit by mid June suggesting that N and K should be applied before mid June to meet the crop demand. N and K demand is high early in the season however there is currently a lack of data on root growth and remobilization from storage and hence it remains uncertain how postharvest and early spring fertilization contributes to N efficiency. Preliminary analysis of soil and plant perennial organs suggests that trees receiving 125lb per acre N are depleting their soil and plant reserves. N application over 275lb per acre did not result in yield increase while NUE decreased along with increased incidence of hull rot. NUE of over 88% for N rate 275lb per acre in terms of N applied as fertilizers and N export in fruits suggest the system in very efficient.

**Table 2.** Effect of nitrogen rate and source on plot mean kernel yield (lb/ac) in 2011. Yield not connected by the same letters are significantly different.

Treatment	Mean Kernel yield 2011 (lb/ac)							
	N UAN 32				N CAN 17			
	A 125	B 200	C 275	D 350	E 125	F 200	G 275	H 350
Drip Irrigation	3,811 C	4,274 B	4,643 A	4,735 A	3,640 C	4,336 B	4,864 A	4,852 A
Fan Jet Irrigation	3,870 B	4,014 B	4,480 A	4,425 A	3,803 C	4,159 B	4,452 A	4,398 A

**Table 3.** Effect of potassium rate and source on kernel yield (lb/ac) 2011. Yield not connected by the same letters are significantly different.

Treatment	Mean Kernel yield 2011 (lb/ac)					
	K Rate			K Source		
	I 100	C 200	J 300	C 200	K 200	L 200
Drip Irrigation	4,700 A	4,643 A	4,774 A	4,723 A	4,791 A	4,804 A
Fan Jet Irrigation	4,382 A	4,480 A	4,498 A	4,471 A	4,362 A	4,348 A

**Table 4.** Cumulative Nitrogen Use Efficiency 2008-2011. Calculated as total N outputs in all fruit divided by total N inputs (fertilizer and irrigation water).

N Rate (lb/ac)	Drip	Fan Jet
125	1.43	1.30
200	1.03	1.03
275	0.93	0.88
350	0.82	0.70

## LITERATURE REVIEW

- Beutel J, Uriu K, Lilleland O. 1978. Leaf analysis for California deciduous fruits. In: Reisenauer HM (ed.) soil and plant-tissue testing in California. Pp 11-14.
- Brown P. H., and Uriu K. 1996. Nutrition deficiencies and toxicities: diagnosing and correcting imbalances. In: Almond production manual. University of California, Division of Agriculture and Natural Resources. Publication 3364.
- Halevy J, Marani A, Markovitz T. 1987. Growth and NPK uptake of high yielding cotton grown at different nitrogen levels in a permanent-plot experiment. *Plant and Soil* 103, 39-44
- Huett DO 1986. Response to nitrogen and potassium of tomatoes grown in sand culture. *Aust. J. Exp. Agric.*, 1986, 26, 133-138
- Karlen, D.L; Flannery, R. L and Sadler E. J. 1988. Aerial Accumulation and Partitioning of Nutrients by Corn. *Agron. J.* 80:232-242
- Meyer RD. 1996. Potassium fertilization/foliar N/P/K/B studies. In: Almond Board of California. 1972-2003. Years of discovery. pp 291-292.
- Nyomora AMS, Brown PH, Krueger B. 1999. Rate and time of boron application increase almond productivity and tissue boron concentration. *HortScience* 34: 242-245.
- Reidel EF, Brown PH, Duncan RA, Heerema RF, Weinbaum SA. 2004. Sensitivity of yield determinants to potassium deficiency in 'Nonpareil' almond (*Prunus dulcis* (Mill.) DA Webb). *J Hort. Sci Biotech.* 79: 906-910.
- Uriu K. 1976. Nitrogen rate study. In: Almond Board of California. 1972-2003. Years of discovery. p 287.
- Weinbaum SA, Carlson RM, Brown PH, Goldhamer DA, Micke WC, Asai W, Viveros M, Muraoka TT, Katcher J, Teviotdale B 1990. Optimization of nitrogen use. In: Almond Board of California. 1972-2003. Years of discovery. pp 289-290.
- Ulrich A, Hills FJ. 1990. Plant analysis as an aid in fertilizing sugarbeet. In: Westerman RL (ed.) *Soil testing and plant analysis*. 3rd ed. Soil Science Society of America, Inc. Book Series 3. Madison, Wisconsin. pp 429-447.

## ACKNOWLEDGEMENT

We thank Almond Board of California and Yara Fertilizers for partially funding this project.

# Determination of Root Distribution, Dynamics, Phenology and Physiology of Almonds to Optimize Fertigation Practices

## PROJECT LEADER

**Patrick Brown**  
Professor  
Department of Plant Sciences  
One Shields Ave.  
University of California  
Davis, CA 95616-8683  
(530) 752-0929  
pbbrown@ucdavis.edu

## CO-PI

**Blake Sanden**  
Irrigation & Agronomy Farm Advisor  
University of California  
Cooperative Extension  
1031 S. Mt Vernon Ave.  
Bakersfield, CA 93307  
blsanden@ucdavis.edu

## COOPERATOR

**Jan Hopmans**  
Professor  
Department of Land, Air and  
Water Resources  
One Shields Ave.  
University of California  
Davis, CA 95616-8683  
jwhopmans@ucdavis.edu

## COOPERATOR

**Andres Olivos**  
Doctorate Student  
Department of Plant Sciences  
One Shields Ave.  
University of California  
Davis, CA 95616-8683  
aolivos@ucdavis.edu

## PROJECT LOCATION

**Belridge Almond Orchard**  
UC Davis greenhouse facilities

## SUPPORTER

**Paramount Farming Company**  
Belridge: Paramount Farming  
Company will provide extensive  
free labor, irrigation design,  
fertilization management, and  
harvest assistance as needed.

## INTRODUCTION

Optimal fertilization practice can only be developed if knowledge of the 4 R's (right source, right rate, right place, and right time) are explicitly developed for the almond production context. To optimize nutrient use efficiency in fertigated almond it is essential that fertilizers injected into irrigation system are provided at the optimal concentration and time to ensure that deposition patterns coincide with maximal root nutrient uptake. This project has been designed to provide critical information about root physiology and phenology and the interaction with soil nutrients and fertigation practices. Results from the different treatments indicate that root physiology is dependent on current soil nutrient status as well as current plant nutrient status. In addition, different fertigation practices showed that applying the same amount of fertilizers and reducing its concentration may be a viable fertigation management strategy to increase efficiency and reduce groundwater contamination.

## OBJECTIVES

1. Determine almond root growth and phenology and characterize root distribution and nutrient uptake activity as influenced by tree nitrogen status, irrigation source, yield and plant characteristics.

2. Determine the patterns and biological dynamics (Km, Vmax, Cmin/max) of tree nitrogen uptake and the relationship to tree demand and phenology.
3. Integrate root phenology and uptake data into the HYDRUS 2D and DNDC model to help interpret and extend findings to a wider range of soils, irrigation and demand scenarios.
4. Publication and extension of results.

## DESCRIPTION

In order to achieve the objectives proposed in this project, two experimental trials have been used contrasting different rates of nitrogen (N), fertigation methods and irrigation methods.

### Nitrogen rate experiment

The trees used in this proposed experiment have been selected from among those currently under investigation in related Board and FREP Projects (Brown/Smart/Sanden/Hopmans). The orchard is a high producing 13 year old Nonpareil/Monterey planting located south of Lost Hills in Kern County. The existing experiments provides preliminary individual tree data on yield, soil and plant water (neutron probe and plant based), plant nutrient status (5 in-season leaf samples), tree nutrient demand (sequential crop estimation and determination),



leaf area index and photosynthesis and  $E_{t_0}$ . The ongoing project of Brown has already established very clear differences in crop yield and nitrogen demand and represents an ideal field site for this work. The treatments are described in **Table 1**.

Twenty minirizotron access tubes were installed in the ongoing experiment to follow root phenology (root flushes, root lifespan, growth, etc.) over multiple seasons under four fertilization regimes. Root images have been taken during the 2012 season in 2 week basis and images will be analyzed recording number of roots, color, diameter and length. Analysis of these images will be performed at the end of each season.

In addition, a total of 80 root bags filled with media were installed in the different treatments and N uptake was measured in excised roots. The relationship between the parameters of root N uptake and tree demand will be determined once yield and N content are obtained by leaf and nut sampling at harvest.

**Fertigation method experiment**

The effect of fertigation technique (pulsed, continuous, drip, microjet) will be examined in a subset of trees in the same orchard as above (**Table 2**) established in 2011.

In this experiment an additional 20 minirizotron access tubes were installed in order to determine root phenology (root flushes, root lifespan, growth, etc.). Root images have been taken during the 2012 season

in 2 week basis and images will be analyzed recording number of roots, color, diameter and length. Analysis of these images will be done at the end of each season.

In addition, 72 soil solution access tubes (SSAT, “lysimeters”) have been installed in each treatment at 3 depths (30, 60, 90 cm) in order to measure nitrate ( $NO_3$ ) concentration and transport through the soil profile at each fertigation event.

Individual trees have been analyzed for leaf nutrient analysis, yield, nut size and crackout percentage and contrasted among treatments (see results section).

**RESULTS AND DISCUSSION**

**Nitrate Uptake by roots**

Fine roots from each treatment in experiment 1, were isolated, excised and then incubated in solutions of different  $NO_3$  concentration for 30 minutes. The external concentration (i.e. soil solution concentration) ranged from 0.42 to 14.01 ppm of  $NO_3$ . According to literature, root uptake of fine roots will depend mostly on the concentration of the external solution as well as the demand of  $NO_3$  by the plant (i.e. plant N status). Preliminary results from this experiment are shown in **Figure 1**. When roots were incubated in solutions from a low range concentration (0.42 to 3.50 ppm of  $NO_3$ ), all of the treatments showed an increase in uptake followed by a saturation at the end of this range; however, low

**Table 1.** Treatments utilized in the current project. Selected trees within RCBD with 6 x 15 tree replicates per treatment.

Treatment	N source	N amount (lbs/ac)
A	UAN32	125
B	UAN32	200
C	UAN32	275
D	UAN32	350

**Table 2.** Fertigation treatments in the ongoing project. Selected trees within RCBD with 4 x 7 tree replicates per treatment.

Treatment	N source	K source	Irrigation Method	Fertilization method
E	100% UAN32	100% SOP	Fanjet	4 fertigation events / year
F	100% UAN32	60% SOP / 40% KTS	Fanjet	Continuous (fertilization in each irrigation)
G	100% UAN32	100% SOP	Drip	4 fertigation events / year
H	100% UAN32	100% SOP	Drip	4 fertigation events / year

N treatments exhibited a higher uptake capacity than the the high N treatments. This results suggests that N starved trees can up regulate N uptake and can access N from lower NO<sub>3</sub> concentrations than trees with sufficient N content. Trees with high N application showed a low capacity to absorb NO<sub>3</sub> and at the lowest NO<sub>3</sub> concentration (0.42 ppm) they lost NO<sub>3</sub> from the roots system to the solution. At high NO<sub>3</sub> concentration ranges (7.01 to 14.01 ppm of NO<sub>3</sub>) however, low N trees exhibited lower uptake capacity than high N status trees. The concentration of NO<sub>3</sub> in the external solution has also been measured in the soil (Figures 3, 4, 5). This is the first year of this experiment and additional analyses and repetitions are required. Future plans include the addition of higher NO<sub>3</sub> concentrations to the sampling methodology, and the experimentation with non-excised

roots (roots will be still attached to the tree) for the incubation period.

### Fertigation Method

The objective of this experiment is to determine the best fertigation practice for almond orchards, and will contrast standard grower practice (4 fertigation events) with fertilizers applied at each irrigation event. The most important goal is to reduce the contamination of groundwater with pollutants (NO<sub>3</sub>) without reducing crop performance.

Preliminary results from soil solution extraction at different soil depths and times are shown in Figures 2, 3, 4 and 5. Results from that analysis of soil solution extraction, showed that fertigation practices that include the application of the same amount of fertilizer

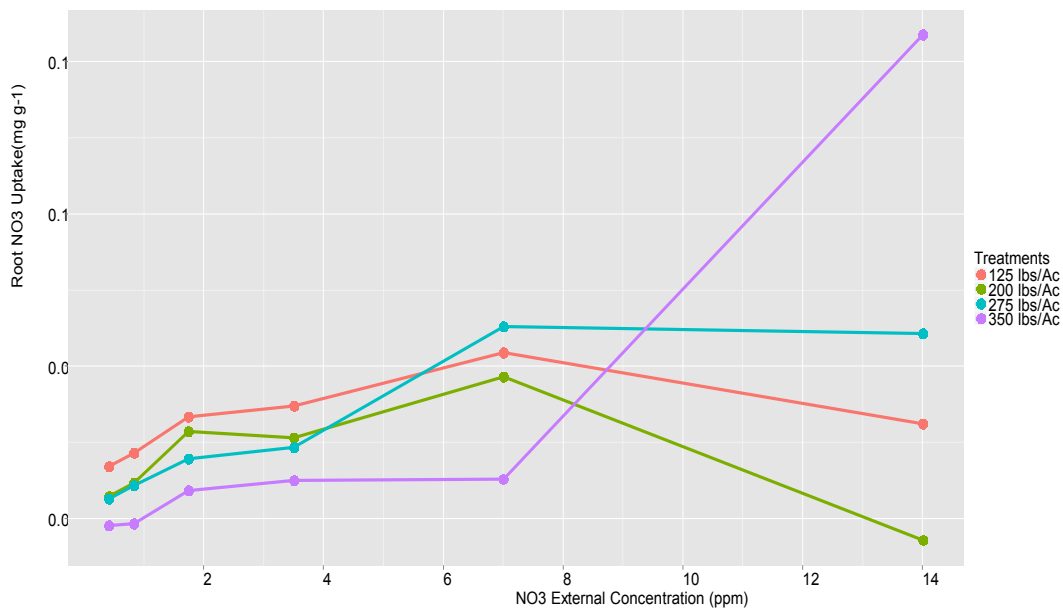

Figure 1. N-NO<sub>3</sub> uptake of almond roots at different N-NO<sub>3</sub> external concentrations.

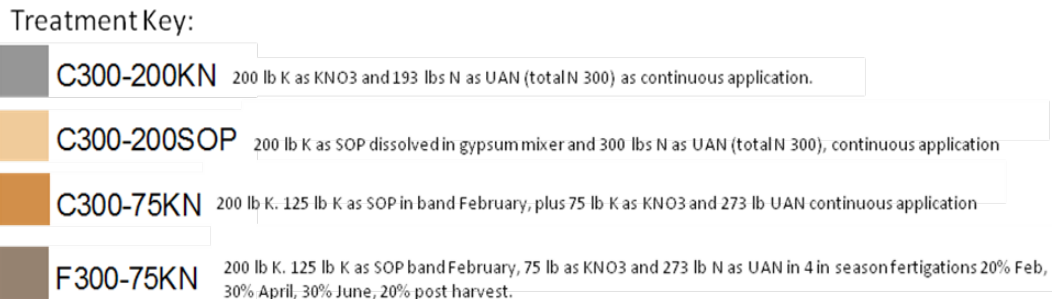
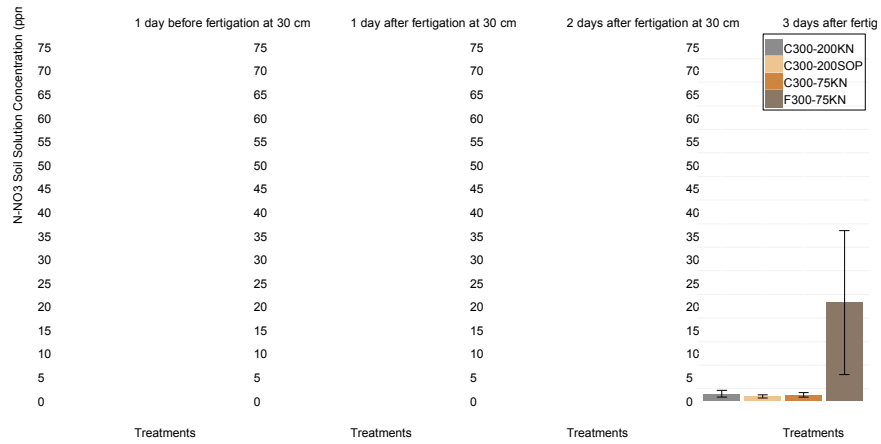
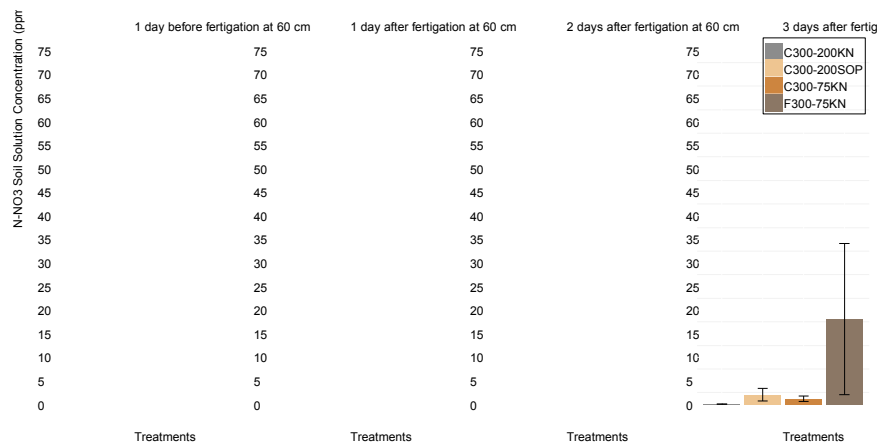

Figure 2. Treatment key for fertigation experiment.



**Figure 3.** Soil solution N-NO<sub>3</sub> concentration (ppm) at 30 cms from soil surface at different times relative to the fertigation event.



**Figure 4.** Soil solution NO<sub>3</sub> concentration (ppm) at 60 cms from soil surface at different times relative to the fertigation event.

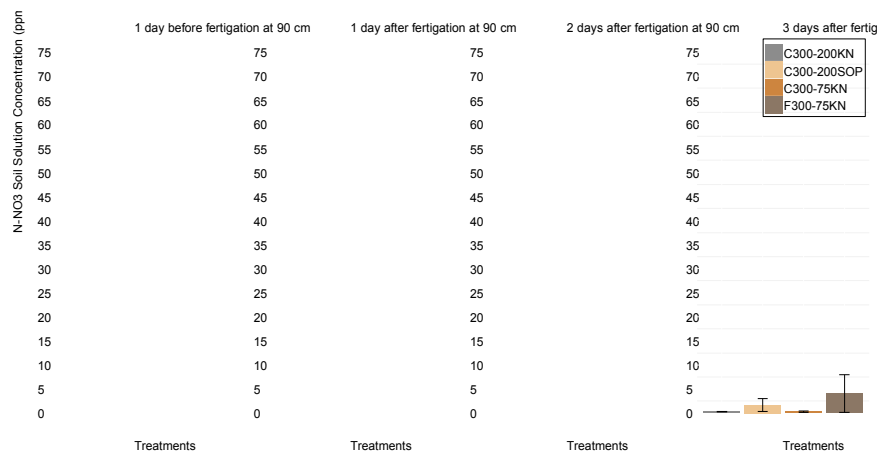

**Figure 5.** Soil solution NO<sub>3</sub> concentration (ppm) at 90 cms from soil surface at different times relative to the fertigation event.

in more events (namely continuous fertigation), are able to reduce the concentration of N-NO<sub>3</sub> in the soil solution at any depth at any time in comparison with the standard practice. At the deepest depth (90 cm), N-NO<sub>3</sub> concentration from continuous fertigation treatments, were much lower than the maximum allowed (10 ppm of N-NO<sub>3</sub>) by CDPH under the federal Safe Drinking Water Act of 1972 (Harter & Lund, 2012). Future plans of this sampling will be the addition of more replication for the experimental setup as well the increment of sampling times.

In terms of productive parameters (yield, nut size, and crackout percentage), results from last season (first year of the experiment) did not show significant effect of the treatments (Table 3). Similarly, leaf nutrient status in mid-summer did not showed any treatment effect (Table 4), with exception of leaf K concentration that was significantly lower in the treatment with no K application.

**LITERATURE CITED**

Harter, T., & Lund, J. R. (2012). Project and Technical Report Outline Technical Report 1 Addressing Nitrate in California’s Drinking Water, (March).

**ACKNOWLEDGEMENTS**

Other Funding: Fluid Fertilizer Foundation: Supplemental funding has been obtained to support this project: \$4,500 Mary Hughes, Fluid Fertilizer Foundation, 2805 Claflin Road, Suite 200, Manhattan, KS 66502, Phone: 785-776-0273. Decagon Devices: 2011: \$5,000 (Instrumentation). Puresense, Inc: 2011: \$10,000 (Instrumentation). Michelle Frey. PureSense Environmental, Inc. 160 Franklin Ave, Suite 160. Oakland, CA 94607, (O) 510.444.1631. This activity is supported in the amount of \$40,000 per annum for three years (\$160,000) by the Almond Board of California.

**Table 3.** Effect of fertigation practices on almond yield, nut size and crackout percentage

Treatments	Yield (lbs/Ac)	Weight/100 Almonds (g)	Crackout (%)
F300-75KN *	4577.4 a	116.95 a	0.26 a
F300-75KTS	4541.5 a	118.26 a	0.27 a
F300-0K	4631.4 a	114.01 a	0.27 a
C300-200SOP *	4436.0 a	114.19 a	0.25 a
C300-75KN *	4598.8 a	119.46 a	0.27 a
C300-150KCL150KN	4798.6 a	116.50 a	0.26 a
C300-200KN *	4980.7 a	116.92 a	0.26 a
C300-300KN	4944.2 a	118.47 a	0.26 a

**Table 4.** Effect of fertigation practices on mid-summer leaf nutrients

Treatments	Leaf N (%)	Leaf P(%)	Leaf K(%)
C300-150KCL150KN	2.79 a	0.13 a	1.08 ab
C300-200KN	2.83 a	0.14 a	1.17 a
C300-200SOP	2.89 a	0.13 a	1.16 a
C300-300KN	2.74 a	0.13 a	1.23 a
C300-75KN	2.86 a	0.14 a	1.28 a
F300-0K	2.78 a	0.13 a	0.83 b
F300-75KN	2.78 a	0.13 a	1.19 a
F300-75KTS	2.76 a	0.13 a	1.24 a



# Chemistry, Fertilizer, and the Environment – A Comprehensive Unit

## PROJECT LEADER

**Judy Culbertson**  
Executive Director  
California Foundation for  
Agriculture in the Classroom  
2300 River Plaza Drive  
Sacramento, CA 95833-3293  
(916) 561-5625  
judy@learnaboutag.org

## PROJECT LEADER

**Mandi Bottoms**  
Curriculum and Evaluation  
Specialist  
California Foundation for  
Agriculture in the Classroom  
2300 River Plaza Drive  
Sacramento, CA 95833-3293  
(916) 561-5625  
mandi@learnaboutag.org

## COOPERATOR

**Corrie Pelc**  
California Fertilizer Foundation  
Director of Programs  
4460 Duckhorn Drive, Suite A  
Sacramento, CA 95834  
(916) 574-9744

## INTRODUCTION

California is the leading agricultural producer in the United States. As the population increases and farmland disappears to commercial and residential development, it is becoming increasingly important for farmers and ranchers to produce food, clothing, forest, and floral products on less land for more people. Fertilizer plays a crucial role in improving agriculture efficiency. Students are part of our consumer population and will be our leaders and decision-makers in the future. It is essential, for the vitality of our industry, to educate young people about fertilizer's role in agriculture and empower them to make informed decisions as they mature to adults. There is a tremendous need for teacher resources that address the challenges facing agriculture and the plant nutrient industry's role in overcoming some of those challenges, our role in environmental stewardship and care, and the science behind agriculture production. The proposed curriculum will address these topics while meeting the Content Standards for California Public Schools.

## OBJECTIVES

1. Create a comprehensive, five-lesson unit to educate students in grades 8 through 12 about the relationship between chemistry, fertilizer, and the environment.
2. Develop five "Grab 'n' Go" teacher training kits to introduce teachers to the above-mentioned curriculum and support classroom instruction.
3. Update and align the existing unit *What Do Plants*

*Need to Grow?* to the California Content Standards for Public Schools and the Common Core State Standards.

4. Increase student understanding of the essential role of plant nutrients in agriculture production.
5. Enhance student appreciation of the agriculture industry's efforts to improve environmental stewardship.
6. Encourage students to pursue a career in plant sciences.

## DESCRIPTION

The goal of this project is to create and implement educational activities that result in adoption and appreciation of fertilizer management, practices, and technologies. The development of educational materials about the role fertilizer plays in our society will educate students, teachers, and the general public about the relationships between fertilizers, food, nutrition, and the environment.

All educational materials developed by the California Foundation for Agriculture in the Classroom are developed by experienced and credentialed educators. Additionally, teachers and industry experts are engaged in reviewing, editing, and testing the curriculum. The resources are made available at no cost to all California teachers.



# Measuring and Modeling Nitrous Oxide Emissions from California Cotton, Corn, and Vegetable Cropping Systems

## PRINCIPAL INVESTIGATOR

**Dave Goorahoo**  
Associate Professor  
Vegetable Crops Production  
Plant Science Department  
California State University  
Fresno, CA  
dgooraho@csufresno.edu

## CO-PI

**Charles Krauter**  
Professor  
Irrigation & Soil Water Management  
Plant Science Department  
California State University  
Fresno, CA  
charles\_krauter@csufresno.edu

## CO-PI

**Shawn Ashkan**  
Research Associate  
Center for Irrigation Technology  
California State University,  
Fresno  
dgooraho@csufresno.edu

## CO-PI

**William Salas**  
Research Scientist- President  
Applied GeoSolutions LLC  
87 Packers Falls Rd  
Durham, NH 03824  
wsalas@agsemail.com

## CO-PI

**Florence Cassel S.**  
Assistant Professor  
Plant Science Department &  
Center for Irrigation Technology  
California State University,  
Fresno  
fcasselss@csufresno.edu

## CO-PI

**Navreet Mahal**  
Graduate Student  
Plant Science Department  
California State University,  
Fresno  
navreetmahal@mail.fresnostate.edu

## COOPERATOR

**Luis Giacomazzi**  
Farmer- Cotton, Corn  
and Forage Grower  
Bob Giacomazzi & Sons  
6668 Grangeville Road  
Hanford, CA 93230

## COOPERATOR

**Dino Giacomazzi**  
Dairy Farmer  
Corn and Forage Grower  
9550 6th Avenue  
Hanford, CA 93230  
dino@giacomazzi.us

## INTRODUCTION

The effects of the anthropogenic increase in atmospheric greenhouse gas (GHG) concentrations on climate change are beyond dispute (IPCC, 2007), and agriculture does play a key role in this issue, both as a source and a potential sink for GHG (California Energy Commission, CEC, 2005). Of the three biogenic GHGs (i.e., CO<sub>2</sub>, CH<sub>4</sub>, and N<sub>2</sub>O) contributing to radiative forcing in agriculture, N<sub>2</sub>O is the most important GHG to be considered, researched, and eventually controlled within intensive and alternative cropping systems. It is estimated that in California, agricultural soils account for 64% of the total N<sub>2</sub>O emissions, and N<sub>2</sub>O may contribute as much as 50% to the total net agricultural greenhouse gas emissions (CEC, 2005). However, the reliability of these estimates is highly uncertain, which stems, in part, from a lack of field measurements in California (CEC, 2005; EPA 2004), and in part, from the inherently high temporal variability of N<sub>2</sub>O flux from soils. In a statistical analysis of 1125 N<sub>2</sub>O studies from all over the world, the average 95% confidence interval was -51% to +107% (Stehfest and Bouwman, 2006). Among California's statewide greenhouse gas emissions, the magnitude of N<sub>2</sub>O emissions is the most uncertain (CEC 2005).

Episodes of high N<sub>2</sub>O fluxes are often related to soil management events like N fertilization, irrigation, or incorporation of crop residue, but the magnitude of

the responses to such field operations also depends on soil physical and chemical factors, climate and crop system. Meta-analyses based on over 1000 studies found that fertilizer N application rates have significant effects on N<sub>2</sub>O emissions, in addition to other factors like fertilizer type, crop type, or soil texture (Bouwman et al., 2002 a and b; Stehfest and Bouwman, 2006). Many of California's high-value crops are intensively managed in terms of N fertilizer use and irrigation, which are factors that have the potential to contribute to substantial N<sub>2</sub>O emissions. Furthermore, California's mild winter temperatures and erratic rainfall patterns may be conducive to sporadic high N<sub>2</sub>O emissions in the winter. The intensive management of cropland and the dependence on irrigation might also present opportunities to optimize management practices in order to mitigate N<sub>2</sub>O emissions. However, the establishment of an improved estimate of N<sub>2</sub>O emissions based on field measurements that capture both the temporal variability of N<sub>2</sub>O emissions and a range of environmental conditions representative for California's main crop systems must precede any mitigation strategies.

## OBJECTIVES

The overall goals of this project are to: (1) determine detailed time series of N<sub>2</sub>O fluxes and underlying factors at crucial management events (irrigation, fertilization,

etc.) in representative agro-ecosystems in the Central Valley of California; and, (2) utilize the intensive data on N<sub>2</sub>O fluxes to calibrate and validate processed based biogeochemical De-Nitrification - De-Composition model (DNDC). Specific objective of this phase of the project is to determine N<sub>2</sub>O flux measurements for silage corn, cotton and tomato cropping systems grown in the central San Joaquin Valley (SJV).

## DESCRIPTION, PRELIMINARY RESULTS & FUTURE WORK

### Description

Given the interest in the suitability of current emission factors for estimating N<sub>2</sub>O emission, we are attempting to determine the percentage of N lost to the atmosphere as N<sub>2</sub>O from added N fertilizer will be determined for corn, cotton and vegetable cropping systems. A system's approach that considers N fertilization, crop N use, N loss as N<sub>2</sub>O, and the soil physical and chemical environment is being employed. We anticipate that through intensive measurements of N<sub>2</sub>O flux in the field for two consecutive years during periods with high N<sub>2</sub>O emission potential, and less frequent, but regular monitoring of N<sub>2</sub>O emissions when fluxes are low, baseline and event related N<sub>2</sub>O emission will be calculated for each N addition treatment and crop system.

During 2011, we continued collecting gas samples from the seven Sites (A to G) with the general description and specific objectives as listed below.

#### Site A- Silage Corn

**Location:** Hanford, CA  
**Crop/Variety:** Corn/Dekalb RX940RR2  
**Soil Type:** Fancher's Sandy Loam, Furrow irrigated.  
**Objective:** To determine of N<sub>2</sub>O fluxes following fertilization and irrigation events for silage corn fertilized with dairy effluent.

#### Site B- Silage Corn

**Location:** Hanford, CA  
**Crop/Variety:** Corn/Dekalb RX940RR2  
**Soil Type:** Fancher's Sandy Loam, Furrow irrigated.  
**Objective:** To determine of N<sub>2</sub>O fluxes following fertilization and irrigation events for silage corn fertilized with Urea Ammonium Nitrate (UAN 32).

#### Site C- Cotton

**Location:** Hanford, CA  
**Crop/Variety:** Cotton/Acala  
**Soil Type:** Fancher's Sandy Loam, Furrow irrigated.  
**Objective:** To determine of N<sub>2</sub>O fluxes in cotton beds and furrows following fertilization and irrigation events

for cotton with Urea Ammonium Nitrate (UAN 32).

#### Site D- Silage

**Location:** Fresno, CA  
**Crop:** Corn  
**Soil Type:** Sandy Loam, Furrow irrigated.  
**Objective:** Comparison of soil N<sub>2</sub>O concentrations measured in silage corn with flux chambers and the INNOVA 1412 device.

#### Site E- Cotton

**Location:** Fresno, CA  
**Crop/Variety:** Cotton/Pima  
**Soil Type:** Sandy Loam, Furrow irrigated; Completely randomized blocks comprising of three N rates = 50, 100 and 150 #N/ac along with treated and non-treated with Nutrisphere. Also included as a control are plots with no fertilizer additions.  
**Objective:** To determine of N<sub>2</sub>O fluxes following fertilization and irrigation events for cotton with Urea Ammonium Nitrate (UAN 32) combined with a nitrogenase inhibitor.

#### Site F- Fresh Market Tomatoes

**Location:** Fresno, CA  
**Crop/Variety:** Tomatoes/Quality 21  
**Soil Type:** Sandy Loam, Subsurface drip irrigated.  
**Objective:** To determine of N<sub>2</sub>O fluxes following fertilization and irrigation events for tomatoes subjected to elevated Carbon Dioxide (CO<sub>2</sub>) levels.

#### Site G- Fresh Market Tomatoes

**Location:** Fresno, CA  
**Crop/Variety:** Tomatoes/Quality 21  
**Soil Type:** Sandy Loam, Subsurface drip irrigated.  
**Objective:** To determine of N<sub>2</sub>O fluxes following fertilization and irrigation events for tomatoes treated with varying UAN 32 fertilizer rates.

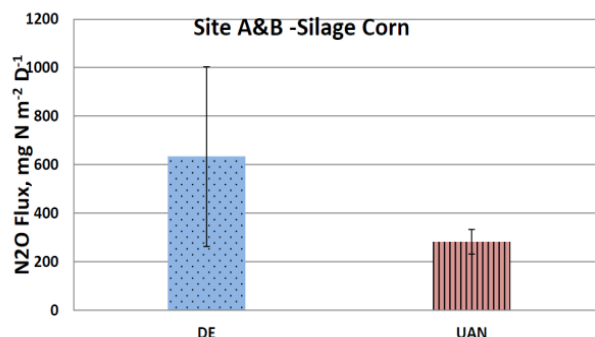

**Figure 1.** Example of N<sub>2</sub>O fluxes measured at site A & B -Silage corn in Hanford.



## Results

During 2012, in addition to collecting gas samples during the growing season, a major emphasis was analyzing the concentration data in an effort to determine  $N_2O$  fluxes following agronomic practices. Examples of the  $N_2O$  fluxes are shown below for the respective sites.

### Preliminary Findings

Preliminary findings from the cotton sites indicated that  $N_2O$  emissions were influenced by N fertilizer rates and irrigation events. For example, field measurements of  $N_2O$  fluxes at the Fresno State site ranged from less than 10 to 40  $\mu g N/m^2/h$  for plots receiving 50 to 100lbs N/acre, respectively. After an irrigation event, these fluxes ranged from 20 to 80  $\mu g N/m^2/h$ . More importantly, the nitrogenase inhibitors reduced  $N_2O$  fluxes by as much as 50%. For the Hanford site,  $N_2O$  fluxes from beds averaged 128  $\mu g N/m^2/d$ , which was approximately 31%

more than that detected from the furrows. In the case of the tomatoes, the  $CO_2$  enhanced plots seem to emit more  $N_2O$  (Figure 5) than those plots exposed to ambient  $CO_2$  levels, and as expected there was positive correlation with fertilizer rates and  $N_2O$  emissions (Figure 6).

### Future Work

$N_2O$  flux data will now be incorporated into DNDC model. A primary goal for the rest of 2012 will be the calibration and validation of this model to predict  $N_2O$  emissions from the various cropping systems identified in this study.

## CONCLUDING REMARKS

During the latter part of 2011 and the first six months of 2012, we continued our collaboration with the UC Davis scientists to guarantee that similar methodologies and monitoring equipment were used for collecting the  $N_2O$  data. This will ensure that any data collected by the both

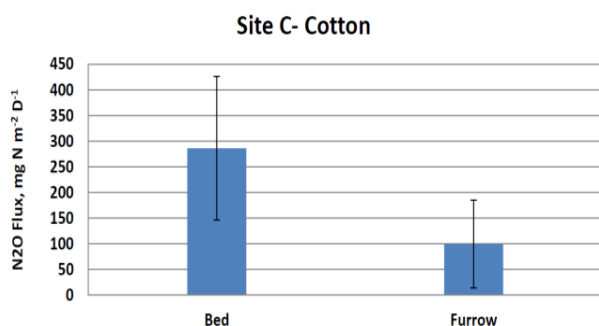

Figure 2. Example of  $N_2O$  fluxes measured in the cotton bed and furrows at site B.

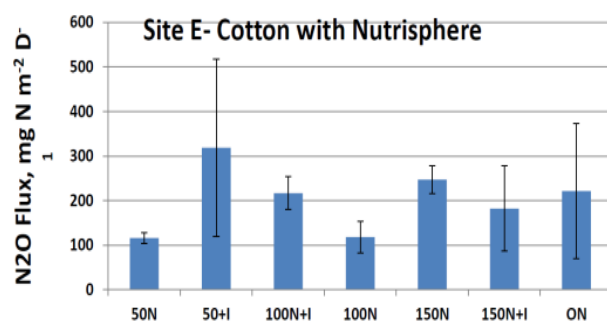

Figure 3. Example of  $N_2O$  fluxes measured for cotton fertilized with UAN 32 and either with or without nitrogenase inhibitor (site C).



Figure 4. Photos of the open top chambers in which tomatoes were subjected to elevated  $CO_2$  levels.

research groups are interchangeable and can be used for comparison and computer modeling purposes. Since our last summary in October 2011, our major focus has been on the conversion of the concentration data to flux data, as depicted in the examples presented in this report.

At the off campus corn and cotton experimental sites in Hanford, the cooperators have agreed to let us collect data during any rotation over next year. At the relatively smaller research plots on the Fresno State campus, we will continue to use these primarily for methodology and protocol development, and sampling under more controlled conditions than what may be possible out on the farmer’s fields. At the Fresno State sites, we will continue to improve our expertise with the calibration and field operation of the INNOVA auto-sampling device and will compare data obtained with this device to the data from the flux chambers.

Our next phase of work will also focus on preliminary calibration of the DNDC model for determination of N<sub>2</sub>O emissions from corn and cotton subjected to irrigation and fertilizer practices at sites A to E. Soil, fertilizer, climatic and irrigation data collected will be used as input parameters for the various algorithms inherent in the DNDC model. Ultimately, we will attempt to determine emission factors for N<sub>2</sub>O emissions for the crops based on measurements following irrigation and tillage practices.

## LITERATURE CITED

Bouwman A.F., L.J.M. Boumans, and N.H. Batjes. 2002a. Modeling global annual N<sub>2</sub>O and NO emissions from fertilized fields. *Global Biogeochemical Cycles*. 16(4):1080.

Bouwman A.F., L.J.M. Boumans and N.H. Batjes. 2002b. Emissions of N<sub>2</sub>O and NO from fertilized fields: Summary of available measurement data. *Global Biogeochemical Cycles*. 16(4): 1058.

California Energy Commission. CEC. 2005. Inventory of California greenhouse gas emissions and sinks: 1990 to 2002 update. Prepared in support of the 2005 integrated energy policy report. June 2005 Publication CEC-600-2005-025.

Stehfest, E., and L. Bouwman. 2006. N<sub>2</sub>O and NO emission from agricultural fields and soils under natural vegetation: summarizing available measurement data and modeling of global annual emissions. *Nutrient Cycling in Agroecosystems* 74:207-228

## ACKNOWLEDGEMENTS

In addition to CDFA-FREP grant, matching funds for this research are provided California State University - Agricultural Research Initiative (CSU-ARI) program.

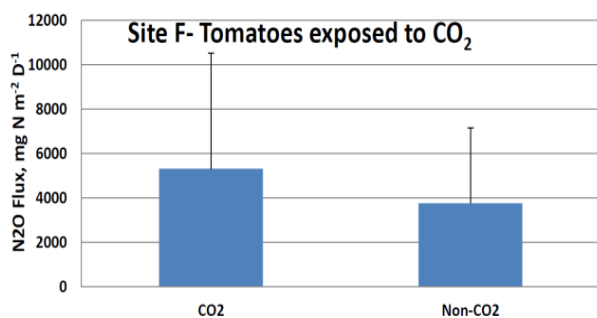

**Figure 5.** Example of N<sub>2</sub>O fluxes measured in tomatoes exposed to elevated CO<sub>2</sub> levels.

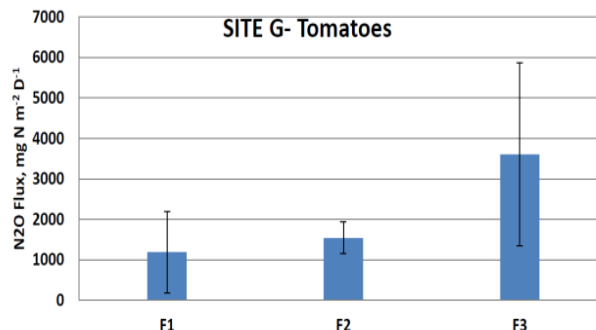

**Figure 6.** Example of N<sub>2</sub>O fluxes measured for tomatoes fertilized with 100 (F1), 150(F2) and 200 (F3) lbs of N/ac during the season and irrigated with subsurface drip irrigation.

# Remediation of Tile Drain Water Using Denitrification Bioreactors

## PROJECT LEADER

### T.K. Hartz

Extension Specialist  
Department of Plant Sciences  
University of California  
1 Shields Ave.  
Davis, CA 95616  
(530) 752-1738  
tkhartz@ucdavis.edu

## PROJECT LEADER

### Mike Cahn

UCCE Irrigation Farm Advisor  
Monterey, San Benito and  
Santa Cruz Counties  
1432 Abbott Street  
Salinas, CA 93901  
(831) 759-7377  
mdcahn@ucdavis.edu

## PROJECT LEADER

### Richard Smith

UCCE Vegetable Crops Farm Advisor  
Monterey, San Benito and  
Santa Cruz Counties  
1432 Abbott Street  
Salinas, CA 93901  
(831) 759-7357  
rifsmith@ucdavis.edu

## PROJECT LEADER

### Laura Tourte

UCCE Farm Management Farm Advisor  
Monterey, San Benito and  
Santa Cruz Counties  
1432 Freedom Boulevard  
Watsonville, CA 95076  
(831) 763-8005  
ljtourte@ucdavis.edu

## INTRODUCTION

Vegetable growers on the Central Coast face an unprecedented challenge from environmental water quality regulation. The Central Coast Region Water Quality Control Board has added new monitoring and reporting requirements to this year's renewal of the Conditional Waiver for Irrigated Lands. The waiver renewal focuses on nitrate ( $\text{NO}_3\text{-N}$ ) pollution abatement; extensive monitoring in recent years has shown that the  $\text{NO}_3\text{-N}$  concentration in surface runoff and tile drain effluent from fields in this region commonly exceeds the Federal drinking water standard of 10 ppm. While better fertilizer management practices can reduce the  $\text{NO}_3\text{-N}$  load in agricultural wastewater, it is clear that some remediation will also be needed to meet environmental targets. Of the techniques that have been considered for the remediation of agricultural wastewater, biological denitrification (BD) appears to be the most promising. BD is a passive process in which bacteria reduce  $\text{NO}_3^-$  to gaseous N compounds (mostly  $\text{N}_2$ ). The requirements for BD to occur are an anaerobic environment, the presence of bacteria capable of this transformation, and labile carbon to power bacterial growth and act as a terminal electron acceptor. This process occurs naturally in wetlands, but limited availability of labile carbon limits the rate at which denitrification occurs, thereby making the use of wetlands to remediate agricultural wastewater problematic.

An alternative approach to harnessing BD is the use of a denitrification bioreactor. A bioreactor consists of a chamber filled with an organic waste material through which agricultural wastewater flows. The organic

waste material (most often wood chips) supplies labile carbon while providing a physical matrix on which the denitrifying bacteria can grow. Bioreactors have been evaluated in various agricultural areas around the world, with reasonably consistent success. This project is testing this technique under commercial field conditions in the Salinas Valley.

## OBJECTIVES

1. Evaluate the environmental and economic feasibility of denitrification bioreactors for the removal of nitrate from tile drain effluent and surface runoff.
2. Extend the results of this research to coastal vegetable growers to stimulate action toward compliance with water quality regulation.

## DESCRIPTION

Two pilot-scale bioreactors were constructed in 2011 on tile-drained commercial vegetable farms in the Salinas Valley. Pits of approximately 930  $\text{ft}^3$  (site 1) and 450  $\text{ft}^3$  (site 2) were dug, lined with polyethylene sheeting, and filled with chipped wood waste obtained from the Monterey Regional Waste Management District. This material, made by grinding untreated scrap construction wood, is available in sufficient quantity (approximately 7,500 tons per year) to represent a potential source of carbon-rich media for commercial-scale bioreactors in this region. Pumps were installed in the collection sumps of the farms' tile drain systems. Tile drain water is continuously pumped into the bioreactors at a rate to provide approximately 2 days of residence time in the reactors before the water is released into the surface

ditch draining the farm. Beginning in May (site 1) or June (site 2), 2011, inlet and outlet water from the reactors has been sampled 2-3 times per week during the crop production season, and once per week during the winter. The water collected has been analyzed for nitrate-nitrogen ( $\text{NO}_3\text{-N}$ ) and dissolved organic carbon (DOC).

In May, 2012, a pilot-scale bioreactor was constructed on a commercial farm in the Salinas Valley (site 3) to evaluate the remediation of surface runoff from vegetable fields. This reactor is approximately 430  $\text{ft}^3$  in volume, and contains the same wood waste medium used for the 2011 bioreactors, although of a finer grind (most chips < 1", whereas the 2011 bioreactors were filled with 1-2" chips). Water is continuously pumped into the bioreactor from a tailwater collection pond. Because this water contains a sufficient sediment load to foul the bioreactor, the water is pre-treated with polyacrylamide (PAM) to flocculate soil particles before it is pumped into the bioreactor. This reactor has been operational since June 1, 2012.

### RESULTS AND DISCUSSION

A high level of DOC was present initially in the outflow from all bioreactors (Figure 1), but declined to approximately 20 ppm after several weeks of operation. High DOC may stimulate the biological oxygen demand of the receiving waters. Additionally, the color of the reactor effluent in those initial weeks of operation was quite dark, suggesting that complex organic compounds were being leached from the wood chips. To minimize any adverse environmental effects arising from the operation of a bioreactor, water released during the initial weeks of operation might best be reapplied on-farm, perhaps as pre-irrigation water. Tile drain effluent presents a potential problem in this regard, as it can be relatively high in salinity (the

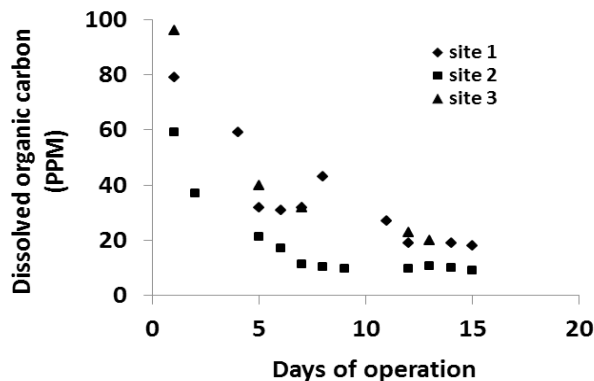

Figure 1. Dissolved organic carbon concentration of denitrification bioreactor effluent in the initial weeks of operation.

average electrical conductivity of bioreactor effluent at sites 1 and 2 has been 2-3  $\text{dS/m}$ ). After a few weeks of operation, bioreactor effluent does not appear to pose any environmental risk not present in the original wastewater.

At all sites denitrification began within days of the initial filling of the bioreactors; denitrifying bacteria are ubiquitous, and ‘seeding’ of inoculum was not necessary. High initial denitrification rates slowed as the reactors matured, undoubtedly related to reduced carbon availability. Once the reactors at sites 1 and 2 reached a ‘steady state’ condition, denitrification rates averaged approximately 8 ppm  $\text{NO}_3\text{-N}$  per day of residence time during the rest of the 2011 irrigation season (July through October), and approximately 5 ppm during the winter (Figure 2). Denitrification rates from May through July, 2012, have been similar to those achieved during the first summer of operation, suggesting long-term stability of performance. Equipment problems at both sites periodically resulted in residence time longer than 2 days; the mean daily denitrification rates cited have been adjusted for these events.

The initial months of operation at site 3 have been encouraging. Surface runoff  $\text{NO}_3\text{-N}$  concentration has ranged between 20-50 ppm. Between 2-3 days of residence time in the bioreactor has been sufficient

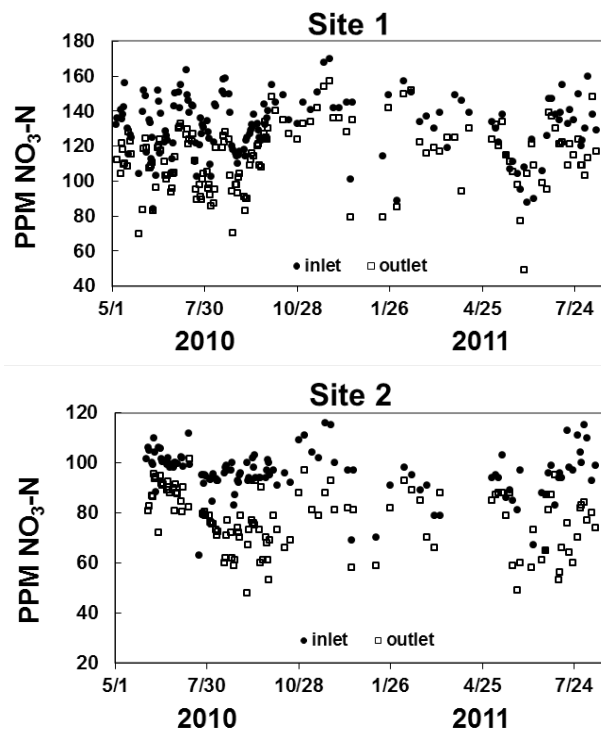

Figure 2. Reduction of water  $\text{NO}_3\text{-N}$  concentration in denitrification bioreactors treating tile drain effluent.



to reduce  $\text{NO}_3\text{-N}$  to below 10 ppm on average. The denitrification rate of this bioreactor may decline at it 'matures', but it is possible that the smaller wood chips used at site 3 will continue to support higher denitrification rates than at sites 1 and 2 due to higher carbon availability and/or greater surface area on which the denitrifying bacteria can grow. Furthermore, the temperature of surface runoff has averaged about 8 °F higher than the tile drain effluent, encouraging greater denitrification.

The lower initial  $\text{NO}_3\text{-N}$  concentration of surface runoff compared to tile drain effluent makes the use of this technology more practical for the treatment of surface runoff, provided that efficient sediment removal can be achieved. The simple system of PAM treatment that we are using is removing > 80% of sediment content. To maintain a bioreactor over many years of operation would require an even more efficient system of sediment removal would be required; prior research by Mike Cahn suggested that this should be technically feasible.

Despite the encouraging results to date, significant questions remain regarding the potential of this technology to substantively reduce the water quality

impacts of irrigated agriculture. The costs, and the engineering constraints, of scaling up bioreactors to handle tens of thousands of gallons of tile drain effluent or surface runoff per day have yet to be evaluated. The useful life of a bioreactor is not clear. Some small-scale bioreactors have been in service for more than a decade in the Midwest. Our initial experience suggests that the degradation of the wood chips is slow, probably < 10% per year by weight. However, changes in bioreactor hydraulic characteristics, or fouling from sediment content (in the case of surface runoff), may require more frequent renovation. What seems clear is that, to be maximally effective, denitrification bioreactors would be only one element of an integrated irrigation and nutrient management system that minimizes both the volume and  $\text{NO}_3\text{-N}$  load of agricultural discharge.

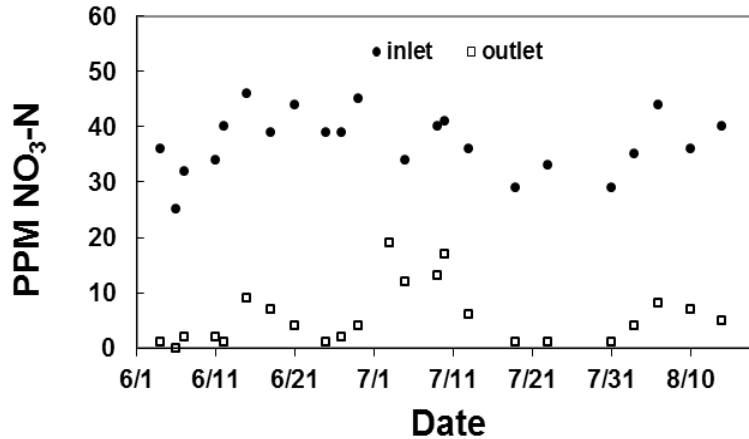

**Figure 3.** Reduction of water  $\text{NO}_3\text{-N}$  concentration in the denitrification bioreactor treating surface runoff (site 3).

# Citrus Yield and Fruit Size Can Be Sustained for Trees Irrigated with 25% or 50% Less Water by Supplementing Tree Nutrition with Foliar Fertilization – Comparison of Conventional Irrigation and Partial Root Zone Drying at the Same Reduced Irrigation Rates Supplemented with Equal Foliar Fertilization

## PROJECT LEADER

**Carol J. Lovatt**  
Professor of Plant Physiology  
Dept. of Botany and Plant Sciences  
University of California  
4130 Batchelor Hall  
Riverside, CA 92521-0124  
(951) 827-4663  
carol.lovatt@ucr.edu

## PROJECT LEADER

**Ben Faber**  
UC Farm Advisor  
Coop. Ext. Ventura County  
669 County Square Drive, #100  
Ventura, CA 93003  
(805) 645-1462  
bafaber@ucdavis.edu

## COOPERATOR

**Stephen Cockerham**  
Superintendent of Agricultural  
Operations  
Agricultural Operations  
1060 Martin Luther King Blvd.  
Riverside, CA 92521  
(951) 827-5906  
stephen.cockerham@ucr.edu

## COOPERATOR

**Philip A. Roberts**  
Professor of Nematology and  
Nematologist  
Chair, UCR Agricultural  
Operations Policy Committee  
Dept. of Nematology  
University of California  
Riverside, CA 92521  
(951) 827-4442  
Philip.Roberts@ucr.edu

## INTRODUCTION

For California citrus growers, the cost of irrigation water is a major expense associated with citrus production. Irrigation water is nearing \$200/acre-foot in the San Joaquin Valley. Moreover, the future availability of water necessary for crop production is in question; growers may have to produce their crops with 30% less water (<http://www.latimes.com/news/local/la-me-water21nov21,1,1338299.story>, <http://www.Fresnobee.com/business/story/222120.html>). Micro-jet and drip irrigation systems have contributed significantly to increasing water-use efficiency and reducing the amount of water used annually in citrus orchards. Regulated deficit irrigation (RDI) and partial root zone drying (PRD) were developed to further improve water-use efficiency in perennial fruit tree crops to further reduce water use and expense (Kriedemann and Goodwin 2003). Both methods limit the vigor of vegetative shoot growth in favor of crop development with the goal that neither the current nor return yield is negatively affected. It is important to note that reducing vegetative shoot growth is considered an important factor in controlling Asian Citrus Psyllid populations and the spread of Huanglongbing in citrus. With RDI, water deficit is applied in an orchard in a carefully controlled manner during a specific period in the phenology of the tree. When using RDI, timing is critical. RDI was shown to have limited utility in navel orange production in California (Goldhamer 2003). In contrast, PRD is the practice of alternately wetting and drying the root zone on two sides of the tree. With PRD, timing is flexible, and PRD is employed year-round. PRD is being used

over RDI in commercial sweet orange production in Australia. In a 4-year field study, 40% less water was applied by PRD than the fully irrigated control, resulting in significant savings in water use (32%-43% less than the district average for citrus orchards) with no significant effect on fruit number, size or quality, with the exception that the ratio of solids to acid in the juice was lower than that of the control in the first year of the experiment (Loveys et al. 1999). Our research goal is to meet the challenge of California's water shortage crisis by demonstrating that yield of commercially valuable large-size navel orange fruit (transverse diameter 6.9-8.8 cm; 2.7-3.5 inches) can be sustained despite irrigating citrus trees with 25% or 50% less water. The proposed research will test the feasibility of using partial root zone drying (PRD) to reduce the amount of water and soil (irrigation-applied) fertilizer used in citrus production combined with foliar fertilization to sustain the yield of commercially valuable large fruit (Boman 2002, Lovatt 1999) and, thus, increase grower net profit. Our approach increases water- and nutrient-use efficiency (WUE and NUE). Our research goal of testing PRD to reduce water use in citrus production and to increase grower net income is not only timely, it might be critical to the sustainability of California's citrus industry.

## OBJECTIVES

1. To reduce annual water use in a commercial navel orange orchard by alternately wetting and drying the root zone on two sides of the tree using irrigation rates, which are 25% and 50% less than the well-watered control under conventional irrigation (CI).

2. To compare the PRD treatments with CI at the reduced rates (CI-RR) of 25% and 50% less than the well-watered control.
3. To determine the effect of supplementing PRD and CI-RR treatments with foliar fertilization (especially N and K to ensure adequate nutrition to sustain yields of large-size fruit) on yield, fruit size and quality and on return bloom for two crop-years compared to well-watered control trees receiving soil fertilization.
4. To provide a cost:benefit analysis of the results to the growers.

## DESCRIPTION

The design was a randomized complete block with five irrigation treatments and five replications of each treatment in a commercial navel orange orchard at the University of California-Riverside Citrus Research Center and Agricultural Experiment Station. Each treatment was applied to three parallel rows and the internal three trees of five consecutive trees in the middle row of the three rows were used for data collection. Thus, there were two buffer rows between data rows and two buffer trees within a row between data trees for different treatments. The irrigation treatments were: (1) well-watered control (based on evaporative demand) – trees had an emitter on each side of the five trees within the row so that both sides of the tree were watered; (2) PRD-25% – 25% less water than well-watered control – trees had an emitter on each side of the five trees within the row, which alternated in delivery of water to one side of the tree and then the other; (3) PRD-50% – 50% less water than well-watered control – trees had an emitter on each side of the five trees within the row that alternated in delivery to one side of the tree and then the other; (4) CI-RR-25% – 25% less water than well-watered control – trees had an emitter on each side of the five trees within the row so that both sides of the tree were watered; and (5) CI-RR-50% – 50% less water than well-watered control – trees had an emitter on each side of the five trees within the row so that both sides of the tree were watered. One Bermad flow meter was used per treatment to control the rate of irrigation. Pressure regulators were used to maintain pressure to ensure an accurate rate of delivery. The emitters were Bowsmith Fan Jets. Evaporative demand based on CIMIS was used to set the amount of water to be applied to the well-watered control trees. Irrigation amounts were based on UCR campus-based CIMIS ET calculations using current and historic weather data to project the irrigation needs for the well-watered control trees for the up-coming three or four days, respectively. PRD- and CI-RR-treated trees received that amount reduced as specified by the

treatment. Soil moisture content was measured at depths of 30 and 60 cm on each side of a PRD data tree in each treatment and one in the middle for each CI data tree in each treatment for five replications using Watermark Soil Moisture meters. All treatments were irrigated when soil moisture content was  $-30$  cb at a depth of 30 cm for the well-watered control trees. In Years 1 and 2, trees in PRD and CI-RR treatments received reduced soil (irrigation-applied) fertilizer proportional to the reduction in irrigation amount and foliar fertilizer as urea-N (56 kg low biuret urea/ha, 50 lb/acre; 46% N, 0.25% biuret) in mid-January to increase floral intensity (Albrigo 1999, Ali and Lovatt 1992, 1994, Lovatt 1999, Zheng et al. 1988), potassium nitrate (28 kg  $KNO_3$ /ha; 25 lb/acre) in February and again at 75% petal fall (end of April-early May) to increase fruit size and reduce crease (Boman 2002), and urea-N (56 kg urea/ha; 50 lb/acre) at maximum peel thickness (early to mid-July) to increase fruit size (Lovatt 1999). Fertilizers were applied with a 2758 Kpa (400 psi) handgun sprayer in 1869 L of water per ha (200 gallons/acre), adjusted to pH 5.5. Our treatments were designed to not only increase water-use efficiency, but also nutrient-use efficiency. In Year 2, to increase fruit size, trees that had been in the CI-RR-50% and PRD-50% treatments received 25% more water (i.e., 25% less water than the well-watered control trees) starting in April and also received 6-benzyladenine (6-BA) in each of the two irrigation events per week from 1 August through 31 October, for a total of 4 g 6-BA per tree.

Since fruit growth was a sensitive indicator of tree water status and final fruit size was critical to the success of this research, we measured fruit transverse diameter monthly from 1 July through 1 October. In September, 40 spring flush leaves from non-fruiting terminals were collected from around each data tree at a height of 1.5 m (5 ft.). Samples were immediately stored on ice, taken to UCR, washed thoroughly, oven-dried at 60 °C, ground to pass through a 40-mesh screen and sent to the UC-DANR Laboratory at UC-Davis for analysis. Tissue was analyzed for N, S, P, K, Mg, Ca, Fe, Mn, B, Zn, and Cu by atomic absorption spectrometry and inductively coupled plasma atomic emission spectrometry. At harvest, yield (kg and fruit number per tree) and fruit size distribution (pack out) were determined using an in-field fruit sizer. A subsample of 10 fruit per tree were used to determine fruit weight, juice weight, percent juice, juice volume, total soluble solids (TSS), percent acid and solids to acid ratio by the UC Lindcove REC Analytical Laboratory. Each year, treatment effects were determined by ANOVA ( $P = 0.05$ ).

A cost:benefit analysis was performed to determine the efficacy of reducing irrigation in general and by PRD in

particular. Crop value was calculated using the kilograms per tree converted to lbs per tree and the following prices per 40-lb carton: packing carton size 48 - US\$ 20, 56 - US\$20, 72 - US\$16, 88 - US\$13, 113 - US\$ 11, 138 - US\$9 and < 138 - US\$0 (Redlands-Foothill Packinghouse, November 2011, used for Years 1 and 2). Water costs at US\$200/acre-foot and US\$129/acre-foot (1 acre-foot is 325,851 gallons) were calculated using the actual gallons applied per treatment adjusted to an acre. The cost of irrigation-applied fertilizer (80 lb UN32 @ US\$37/acre) (<http://coststudies.ucdavis.edu/files/orangevs2009.pdf>) was reduced by the percent of the reduced irrigation rate. Well-watered control trees also received foliar-applied urea (30 lb low-biuret urea/acre, 46% N, 0.25% biuret) costing US\$27/acre (<http://coststudies.ucdavis.edu/files/orangevs2009.pdf>). The cost of two applications foliar-applied urea (50 lb low biuret urea/acre, 46% N, 0.25% biuret) and potassium nitrate (25 lb KNO<sub>3</sub>/acre), US\$91/acre and US\$35.20/acre, respectively, was added to the expenses for trees in the reduced irrigation treatments. The cost of foliar-application was not included; the cost of the 6-benzyladenine was not included. The cost of the extra-irrigation line for the PRD treatments was not included.

## RESULTS AND DISCUSSION

The liters of water applied per treatment per quarter from January to harvest in November for Years 1 and 2 are given in **Table 1**. Irrigation amounts were based on UCR campus-based CIMIS ET calculations using current and historic weather data to project the irrigation needs for the well-watered control trees for the upcoming three or four days, respectively. This approach was an improvement over simply replacing the water the trees used in the past three or four days – an approach that only by coincidence meets the actual water needs of the trees. Note that January to March is the period of inflorescence development and bud break; April to June is the period of flower opening and fruit set; July to September is the period of exponential fruit growth; and October to harvest in November is the period of fruit maturation.

### Year 1

From 1 January through harvest on 30 November, trees in the CI-RR-25% and PRD-25% treatments received only 16% less water than the well-watered control trees (**Table 1**). The greatest reduction in irrigation water applied to CI-RR-25% and PRD-25% trees was 22%

**Table 1.** Liters of water applied per treatment per quarter from 1 January to harvest on 30 November in Year 1 and from 1 January to harvest on 8 November in Year 2.

Months	Year 1					Year 2				
	Control	CI-RR-25%	CI-RR-50%	PRD-25%	PRD-50%	Control	CI-RR-25%	CI-RR-25% +6-BA	PRD-25%	PRD-25% + 6-BA
	<i>Water applied (liters<sup>2</sup>)</i>									
Jan-Mar <sup>y</sup>	64,502	56,955	51,150	60,503	51,253	114,846	87,168	59,697	90,154	63,050
% control	100.0	88.3	79.3	93.8	79.5	100.0	75.9	52.0	78.5	54.9
Apr-Jun	219,699	201,463	159,941	197,949	175,759	278,220	206,717	200,596	216,177	268,482
% control	100.0	91.7	72.8	90.1	80.0	100.0	74.3	72.1	77.7	96.5
Jul-Sep	277,008	215,512	140,443	219,390	155,124	275,835	204,394	200,532	214,048	224,530
% control	100.0	77.8	50.7	79.2	56.2	100.0	74.1	72.7	77.6	81.4
Oct to Harvest	64,880	51,190	33,218	51,169	34,841	68,817	53,540	53,540	53,333	55,811
% control	100.0	78.9	51.2	80.1	53.7	100.0	77.8	77.8	77.5	81.8
Total	626,089	525,915	386,923	530,923	420,106	737,718	551,813	514,189	573,945	612,306
% control	100.0	84.0	61.8	84.8	67.1	100.0	74.8	69.7	77.8	83.0

<sup>2</sup> 3.7853 liters = 1 gallon

<sup>y</sup> January to March is the period of inflorescence development and bud break; April to June is the period of flower opening and fruit set; July to September is the period of exponential fruit growth; and October to harvest in November is the period of fruit maturation.



from July through harvest. This level of stress and its timing significantly reduced the total yield as kilograms of fruit per tree and significantly reduced the kilograms of commercially marketable fruit (packing carton sizes 56-138, fruit diameters 8.8-6.0 cm; 3.15-2.36 inches) per tree (Table 2). The CI-RR-25% and PRD-25% treatments, however, did not reduce the total number of fruit per tree (Data not shown), indicating that the effect of 22% less water from July to harvest was on fruit growth not fruit retention (Table 2). These data also confirmed that the 10% reduction in irrigation from January through June for the trees in these treatments had no effect on fruit set.

From January through March, trees in the CI-RR-50% and PRD-50% treatments received just 20% less water than the well-watered control. From April through June, the CI-RR-50% and PRD-50% trees received 27% and 20% less water than the well-watered control trees, respectively. From July through harvest, CI-RR-50% and PRD-50% trees received 49% and 44% less water than the well-watered control trees, respectively. For these trees, total kilograms per tree was significantly reduced below that of the well-watered control trees and trees receiving 25% less water by CI-RR and PRD than the

well-watered control trees. In addition, the kilograms of commercially marketable fruit (packing carton sizes 56-138) per tree were significantly less than the well-watered control trees (Table 2). Reducing the irrigation rate 44% and 49% for the CI-RR-50% and PRD-50% treatments, respectively, reduced the total kilograms of fruit of packing carton size 138 per tree compared to trees receiving 22% (CI-RR-25% and PRD-25%) less water than the well-watered control. Trees in the CI-RR-25%, PRD-25%, CI-RR-50% and PRD-50% treatments all produced significantly more fruit that were smaller than packing carton size 138 (< 6.0 cm; 2.46 inches).

As irrigation rate decreased, juice mass (g) and juice volume per fruit decreased below the values for the well-watered control ( $P < 0.0001$ ) (Data not shown). Interestingly, all fruit due to the lower juice volume had higher TSS and percent acidity than fruit from the well-watered control trees ( $P < 0.0001$ ). Since both TSS and acidity changed in parallel, there was no effect of irrigation rate on TSS:acid. Fruit were legally mature despite the low TSS:acid (8.4-9.2; legal maturity is 8.0) at harvest in November.

Foliar-applied fertilizers did not offset the negative

**Table 2.** Year 1. Effect of reducing irrigation 25% or 50% by conventional irrigation (CI-RR) or partial root zone drying (PRD) and supplying foliar-applied fertilizer from 1 January through harvest on 30 November on yield and fruit size (kg/tree) of 'Washington navel orange trees located at the Citrus Research Center and Agricultural Experiment Station of the University of California-Riverside.

Treatment	Crop value US\$ 237 trees/ha	Packing carton size based on transverse diameter (cm)							
		Total	56 8.1-8.8 cm	72 7.5-8.0 cm	88 6.9-7.49 cm	113 6.35-6.89 cm	138 6.0-6.34 cm	<138 <6.00 cm	56+72+88 6.9-8.8 cm
		kg per tree							
Control	12,815.00 a <sup>2</sup>	259.2 a	2.8 a	5.9 a	33.4 a	71.7 a	86.1 a	58.55 b	42.1 a
CI-RR-25%	4,377.00 b	220.0 b	0.1 b	0.7 b	3.2 b	14.8 bc	58.0 b	143.28 a	4.0 b
CI-RR-50%	490.00 c	135.3 c	0.0 b	0.0 b	0.0 b	1.0 c	7.9 c	126.34 a	0.0 b
PRD-25%	4,475.00 b	200.2 b	0.1 b	0.4 b	5.6 b	23.5 b	46.2 b	124.36 a	6.1 b
PRD-50%	1,916.00 bc	154.4 c	0.1 b	0.5 b	2.9 b	6.7 bc	23.5 c	121.40 a	2.7 b
P-value	<0.0001	<0.0001	0.0811	<0.0001	<0.0001	<0.0001	<0.0001	<0.0001	<0.0001

<sup>2</sup> Values in a vertical column followed by different letters are significantly different at the P-value specified by Fisher's Protected LSD Test; US\$ per 237 trees per ha divided by 2.47 = US\$ per 96 trees per acre; cm divided by 2.54 = inches; kg per tree x 2.2046 = lbs per tree.

effects of reduced irrigation, which significantly reduced the number of fruit in all commercially marketable fruit size categories, especially fruit of packing carton sizes 56, 72 and 88. This dramatically reduced the value of the crop and grower total income, even when the irrigation rate was reduced only 22% (CI-RR-25% and PRD-25%) from July to harvest (Table 2).

### Year 2

From January through March, CI-RR-25%, PRD-25%, CI-RR-50% and PRD-50% trees received 24%, 21.5%, 48%, and 45% less water than the well-watered control trees (Table 1). Given the failure of the foliar fertilizer treatments to mitigate the effects of even a 22% reduction in irrigation (CI-RR-25% and PRD-25%) on fruit size in Year 1, starting in April in Year 2, trees that were in the CI-RR-50% and PRD-50% treatments now received 25% less water than well-watered control trees. In addition, the efficacy of applying the cytokinin 6-BA in combination with foliar-applied fertilizer was tested with these trees. From April through June, trees in the CI-RR 25%, CI-RR-25% + 6-BA, PRD-25% and PRD-25% + 6-BA treatments received 26%, 28%, 22% and 3.5% (faulty flow meter) less water than the well-

watered control trees, respectively (Table 1). From July through September, CI-RR-25%, CI-RR-25% + 6-BA, PRD-25% and PRD-25% + 6-BA trees received 26%, 27%, 22% and 19% less water than the well-watered control trees, respectively (Table 1). On-tree fruit diameter measured on 1 August indicated no significant differences in fruit size among treatments (Data not shown). 6-Benzyladenine (6-BA) was applied with the two irrigation events per week from 1 August through 31 October, for a total of 4 g 6-BA per tree. From 1 October through harvest 8 November, CI-RR-25%, CI-RR-25% + 6-BA, PRD-25% and PRD-25% + 6-BA trees received 22%, 22%, 23% and 19% less water than the well-watered control trees, respectively, with the differences for the entire year 25%, 30%, 22% and 17% less water than the well-watered control trees, respectively (Table 1). These differences in irrigation rates had no significant effect on the total yield as kilograms (or number of fruit) per tree compared to well-watered control trees (Table 3). Trees treated with 6-BA tended to yield more fruit per tree (both kilograms and number) compared to trees in the same irrigation treatment not receiving 6-BA. However, all trees in the reduced irrigation treatments (with or without 6-BA) yielded significantly less commercially

**Table 3.** Year 2. Effect of reducing irrigation 25% by conventional irrigation (CI-RR) or partial root zone drying (PRD) and supplying foliar-applied fertilizer from 1 April through harvest on 8 November, with and without irrigation-applied 6-benzyladenine (6-BA) from 1 August to 31 October, on yield and fruit size (kg/tree) of 'Washington' navel orange trees located at the Citrus Research Center and Agricultural Experiment Station of the University of California-Riverside.

Treatment	Crop Value US\$ 237 trees/ha	Packing carton size based on transverse diameter (cm)							
		Total	56 8.1-8.8 cm	72 7.5-8.0 cm	88 6.9-7.49 cm	113 6.35-6.89 cm	138 6.0-6.34 cm	<138 <6.00 cm	56+72+88 6.9-8.8 cm
		kg per tree							
Control	15,520.00 a <sup>y</sup>	239.7 a <sup>z</sup>	14.4 a	45.7 a	34.3 a	65.2 a	45.6 a	33.2 c	94.3 a
CI-RR-25%	10,385.00 bc	218.1 a	8.4 ab	13.8 b	17.0 bc	51.9 a	56.5 a	67.4 ab	39.1 b
CI-RR-25%+6-BA	8,180.00 c	224.0 a	2.7 b	7.8 b	9.6 c	39.8 a	70.1 a	93.6 a	20.1 b
PRD-25%	8,865.00 bc	216.2 a	1.5 b	10.0 b	16.6 bc	48.4 a	61.8 a	77.8 ab	28.2 b
PRD-25%+6-BA	11,628.00 b	237.2 a	2.1 b	19.0 b	26.9 ab	66.1 a	60.0 a	63.1 b	48.0 b
P-value	0.0003	0.7057	0.0128	<0.0001	0.0006	0.1555	0.2878	0.0004	<0.0001

<sup>z</sup> Values in a vertical column followed by different letters are significantly different at the P-value specified by Fisher's Protected LSD Test; US\$ per 237 trees per ha divided by 2.47 = US\$ per 96 trees per acre; cm divided by 2.54 = inches; kg per tree x 2.2046 = lbs per tree.

<sup>y</sup> 6-Benzyladenine (6-BA) was applied in two irrigation events per week from 1 August through 31 October.

valuable large fruit (packing carton sizes 56, 72 and 88) as kilograms fruit per tree (**Table 3**) and number of fruit per tree (Data not shown). However, unlike Year 1, the reduced irrigation treatments did not cause a significant reduction in the kilograms of fruit of packing carton sizes 113 or 138. The reduced irrigation treatments (with or without 6-BA) significantly increased the kilograms of fruit that were smaller than packing carton size 138 (< 6.0 cm; 2.46 inches). Despite the fact that the reduced irrigation treatments (with or without 6-BA) did not reduce total yield, both treatments reduced crop value because they reduced the yield of commercially valuable large fruit (packing carton sizes 56, 72, and 88).

Consistent with Year 1, for trees in all reduced irrigation treatments except trees in the PRD-25% + 6-BA treatment, juice mass and juice volume were significantly lower than that of the well-watered control trees ( $P = 0.002$  and  $P = 0.003$ , respectively) (Data not shown). In Year 2, there was also an increase in TSS and percent acidity for trees in all reduced irrigation treatments except trees in the CI-RR-25% + 6-BA treatment. Since both TSS and acidity changed in parallel, there was no effect of irrigation rate on TSS:acid. All fruit were legally mature (TSS:acid 8.7-9.3).

All trees receiving foliar-applied fertilizer had leaf concentrations of N, P, K, Ca, S, Mg, B, Mn, Zn, Fe, and Cu equal to or greater than the well-watered control trees, but increased nutrient status did not compensate for the negative effect of reduced irrigation on fruit size, crop value and grower income (**Tables 2 and 3**). Supplying trees receiving 25% less water by either CI-RR or PRD than the well-watered control trees with a total of 4 g of the cytokinin 6-benzyladenine per tree from 1 August to 31 October in Year 2 also did not offset the negative effect of water deficit on fruit growth, yield of commercially marketable fruit, and crop value.

One of the more dramatic results of this research was the documentation of how extremely sensitive 'Washington' navel orange fruit growth is to small differences in irrigation rate during the period of exponential fruit growth. In Year 1, differences of only 20% to 22% from July to harvest (30 November) impacted fruit size, reducing the yield of fruit in all marketable size categories, especially the larger, more commercially valuable fruit of packing carton sizes 56, 72 and 88. Further reductions in irrigation rate exacerbated these problems and reduced the total kilograms of fruit per tree. In Year 2, trees in the CI-RR-25% + 6-BA and PRD-25% + 6-BA treatments received 48% and 45% less water from January through March (prior to 6-BA application) with no negative effect on fruit retention or fruit diameter. The total kilograms (and number) of

fruit per tree for trees in these treatments were equal to the well-watered control trees. From April through June and July through September, trees in the PRD-25% + 6-BA treatment received only 3.5% (due to a faulty flow meter) and 19% less water than well-watered control trees, respectively, whereas trees in the CI-RR-25% + 6-BA treatment received, 28% and 27% less water than the control during these periods, respectively. These modest reductions in irrigation rate had no effect on total kilograms per tree, but dramatically reduced the yield of commercially valuable large fruit (packing carton sizes 56, 72 and 88). Taken together the results of our research indicate that a 20%, or even 40%, reduction in irrigation rate (80% or 60% ET) can be tolerated by trees from January through March and a 20% reduction can be tolerated from April to June, but reducing irrigation 20% or less during the period of exponential fruit growth (July-Sept) had a negative effect on the yield of commercially valuable large fruit (packing carton sizes 56, 72 and 88) and on juice mass and volume. Yield reductions in these fruit size categories significantly reduced crop value and grower income. Savings in the cost of water achieved by reducing irrigation rate were negated by lost revenue due to the lower yield of commercially valuable large fruit. Treating trees in reduced irrigation treatments with foliar-applied fertilizer and irrigation-applied 6-BA did not mitigate the negative effect of water deficit on fruit size and crop value and added to the cost of fruit production, further reducing grower income. From these data it is clear that attempting to reduce production costs by reducing irrigation rate requires close monitoring and great care in irrigation management.

## RECOMMENDATION

The California citrus industry produces "picture perfect" navel orange fruit for the fresh fruit market on 124,385 irrigated acres. The cost of irrigation water is a major expense associated with citrus production. The results of our research provide clear evidence of the negative consequences of reducing irrigation rates for navel orange production below 100% ET on yield, fruit size and grower income. Even modest reductions of only 20% imposed during the critical period of exponential fruit growth reduced the yield of commercially valuable fruit (packing carton sizes 88, 72 and 56) and grower income. Extremely careful irrigation management will be required to reduce production costs by reducing irrigation rate. The results of our research also illustrate the significant financial consequences to which growers could be subject if, at some point, they are required to produce their crops with 30% less water (<http://www.latimes.com/news/local/la-me-water21nov21,1,1338299.story>, [Http://www.Fresnobee.com/business/story/222](http://www.Fresnobee.com/business/story/222)

120.html). The data from this project should be helpful to citrus growers for building the case that such a restriction should not be imposed and for negotiating critical water allocations.

## **ACKNOWLEDGEMENTS**

This research was supported in part by the California Department of Food and Agriculture Fertilizer Research and Education Program and the Univ. of California, Riverside Citrus Research Center and Agricultural Experiment Station. The authors thank Eric Jorgenson, Michael Jorgenson, Steve Cockerham, and Dan Bowles for their technical assistance, Sue Lee and Toan Khuong for organizing the harvests, and Toan Khuong for analyzing the data.

## **LITERATURE CITED**

- Albrigo, L. G. 1999. Effects of foliar applications of urea or Nutri-Phite on flowering and yields of Valencia orange trees. *Proceedings of the Florida State Horticultural Society* 112:1-4.
- Ali, A.G. and C.J. Lovatt. 1992. Winter application of foliar urea. *Citrograph* 78:7-9.
- Ali, A.G. and C.J. Lovatt. 1994. Winter application of low-biuret urea to the foliage of 'Washington' navel orange increased yield. *Journal of the American Society of Horticultural Science* 119:1144-1150.
- Boman, B.J. 2002. KNO<sub>3</sub> foliar application to 'Sunburst' tangerine. *Proceedings of the Florida State Horticultural Society* 115:6-9.
- Goldhamer, D. 2003. Using regulated deficit irrigation to optimize size in late harvest navels, p. 9-10. 2003 annual report. Citrus Research Board, Visalia, Calif.
- Kriedemann, P.E. and I. Goodwin. 2003. Irrigation insights number 4: Regulated deficit irrigation and partial rootzone drying. National Program Sustainable Irrigation, Canberra, Australia.
- Lovatt, C.J. 1999. Timing citrus and avocado foliar nutrient applications to increase fruit set and size. *HortTechnology* 9:607-612.
- Lovatt, C.J., Y. Zheng, and K.D. Hake. 1988. Demonstration of a change in nitrogen metabolism influencing flower initiation in citrus. *Israel Journal of Botany* 37:181-188.
- Loveys, B., P. Dry, R. Hutton, and P. Jerie. 1999. Improving the water use efficiency of horticultural crops: Final report. National Program for Irrigation Research and Development, Canberra, Australia.



# Improved Methods for Nutrient Tissue Testing in Alfalfa

## PROJECT LEADER

### Steve Orloff

UC Farm Advisor  
1655 Main Street  
Yreka, CA 96097  
(530) 842-2711  
sborloff@ucdavis.edu

## PROJECT LEADER

### Daniel Putnam

Extension Specialist  
Department of Plant Sciences  
One Shields Ave  
Davis, CA 95616  
(530) 752-8982  
dhputnam@ucdavis.edu

## COLLABORATOR

### Michael Wolf

JL Laboratories  
Modesto, CA

## COLLABORATOR

### Andre Biscaro

UC Farm Advisor  
335-A East K6  
Lancaster, CA 93535  
asbiscaro@ucdavis.edu

## COLLABORATOR

### Chris DeBen

UC SRA  
Department of Plant Sciences  
One Shields Ave.  
Davis, CA 95616

## SUPPORTER

### Aaron Kiess

Executive Director  
CA Alfalfa & Forage Association  
36 Grande Vista  
Navato, CA 94947  
(415) 892-0167

## SUPPORTER

### Innovative Ag Services, LLC

25221 Road 68  
Tulare, CA 93274  
(559) 688-2896

## SUPPORTER

### Tim Hays

WILBUR-ELLIS COMPANY  
P.O. Box 939  
Shafter, CA 93263

## INTRODUCTION

Phosphorus is the most frequently limiting nutrient for alfalfa (*Medicago sativa* L.) in California soils, followed by potassium, sulfur, and sometimes micronutrients. Many growers do not know whether their fields supply adequate amounts of these nutrients, and are unaware whether their fields are deficient, in excess, or adequate.

Soil tests are somewhat effective to detect some nutrient deficiencies such as P and K, and are especially useful before planting. However, plant tissue tests are believed to be far more accurate, especially for ‘in season’ analysis. The plant is a better indicator of the nutrient supplying capabilities of a soil due to variations in rooting depth, nutrient supplying characteristics of specific soils, and soil sampling and lab extraction limitations. Unfortunately, most alfalfa growers do not tissue test and many growers fertilize (or don’t fertilize) based upon past practice or fertilizer company recommendations with little idea of the actual nutrient status of the field. Additionally, tissue testing techniques vary significantly from state-to-state. Better methods are needed to assess the fertility status of alfalfa fields in order to optimize plant uptake which impacts both yield and quality.

Over 950,000 acres of alfalfa were grown in California in 2012—the largest acreage crop in the state. Thus, alfalfa represents an important component of California’s fertilizer and agricultural footprint, especially for potassium and phosphorus due to its acreage and uptake



**Figure 1.** Reduction of water  $\text{NO}_3\text{-N}$  concentration in the denitrification bioreactor treating surface runoff (site 3).

levels. Since the entire above-ground crop is harvested, soils can become deficient after several years of high-yielding alfalfa production, unlike grains, cotton or tree crops when only a portion of the crop yield is removed and the stover or other residue returned to the fields.

Many alfalfa crops in California are routinely tested for forage quality (e.g. fiber, protein and calculated digestibility values) to determine their nutritional value for feeding purposes. If those same cored samples used for forage quality analysis could also be used for nutrient management purposes, it would greatly simplify the process of tissue testing and encourage more careful nutrient management. Using this method, growers may be able to 'pick up' nutrient deficiencies that would otherwise go undetected.

This report is a summary of the final year of data collection on this project. At this writing, field studies are still underway, and a number of samples have yet to be analyzed, so further analysis and interpretation is necessary before final conclusions are developed.

## OBJECTIVES

The objectives of this project are to:

1. Evaluate the feasibility of using a whole-plant sample (similar to cored-bale hay sample) to determine the nutrient status of alfalfa fields.

2. Compare 3 different plant tissue sampling methods for nutrient monitoring (top 6 inches, fractionated plant, and whole-plant sample).
3. Quantify the phosphorus, potassium and sulfur tissue concentration in alfalfa plant as a function of stage of growth
4. Determine alfalfa yield response from phosphorus, potassium and sulfur fertilization
5. Develop critical plant tissue concentration values for whole-plant alfalfa samples
6. Evaluate the accuracy of NIRS analysis to determine nitrogen, phosphorus, potassium, sulfur, boron and molybdenum concentrations

## DESCRIPTION

We conducted several experiments in line with these objectives:

**Survey of Alfalfa Nutrient Concentrations as Affected by Location, Season and Growth Stage.** We sampled commercial alfalfa fields over the season in three different alfalfa production regions (Intermountain area, Sacramento Valley and the High Desert) three times over the season (early, mid, late-season), sampling at the early-bud, late-bud, and 10 percent bloom growth stages at each of the three cuttings. We sampled three ways:

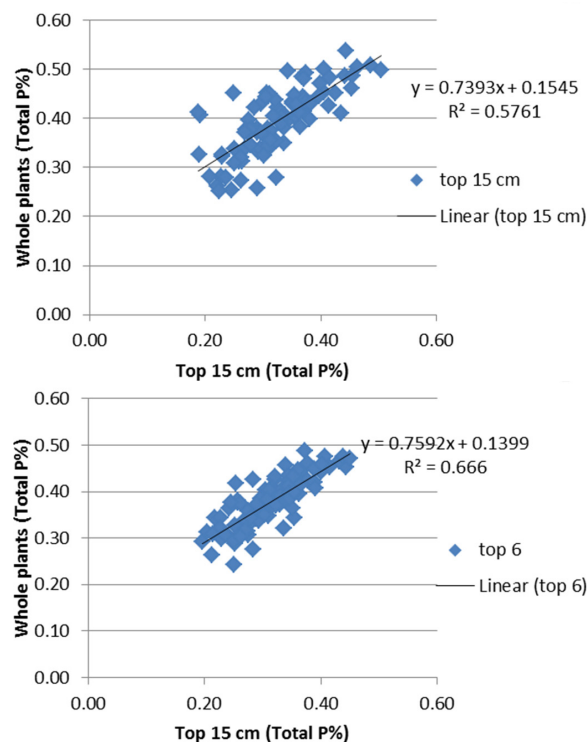

**Figure 2.** Relationship between whole top and top 15 cm sampling protocols for P concentration in alfalfa (All Regions). (A) 2010 and (B) 2011.

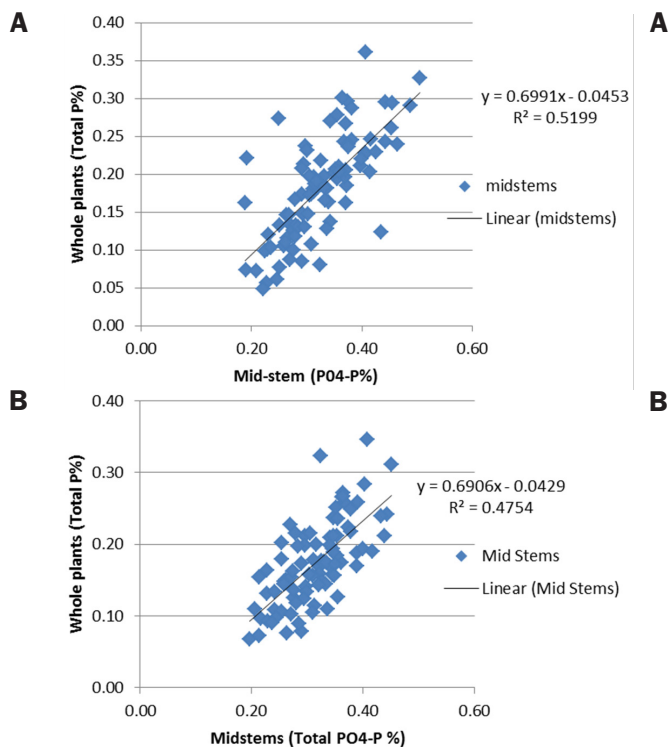

**Figure 3.** Relationship between whole top and mid-stem sampling protocols for P concentration in alfalfa (All Regions). (A) 2010 and (B) 2011.

1) Fractionated plant sample (standard UC protocol), 2) The top 6 inches of the alfalfa plant (method used in other alfalfa-producing states) and 3) Whole plant samples (used in some states and comparable to cored bale samples). Soil samples were also taken. This task will allow us to determine the relationship between the different sampling methods and compare the results with soil analyses.

**Utility of NIRS to predict Nutrient Concentrations.** We used a large set of samples to compare Near Infrared Spectroscopy (NIRS) methodology for prediction of minerals with wet chemistry (standard) procedures. NIRS has the advantage of giving very rapid results, and has also become the standard method for fiber and protein analysis for feed quality. Most hay in California is tested with either wet chemistry or NIRS methods to assess its nutritional value. It would greatly simplify alfalfa tissue testing if reliable equations exist for NIRS that could be used to routinely predict the nutrient status of fields. NIRS scans were performed on sets of samples from 2010 and 2011, in both the UC Davis lab and a cooperating commercial lab (JL Analytical Services).

**Fertilizer Rate Studies.** We conducted fertilizer response trials in the Sacramento Valley for phosphorus and in

the Intermountain area for potassium (phosphorus rate studies have been conducted previously). The purpose was to correlate alfalfa yield with plant tissue nutrient concentration. This research will provide information needed to develop critical tissue levels for whole plant analysis, which can be used to interpret results from cored bale samples.

## RESULTS AND DISCUSSION

As this is the final year of data collection, some samples are still being collected from the field and analyzed by the laboratory, so these results should still be treated as preliminary. However, several key conclusions are becoming apparent as we near the end of this study, in line with the original objectives of the study:

**Feasibility of Using Whole Plant Samples to Detect Nutrient Deficiencies.** Although the  $R^2$  values for the relationship between mid-stem vs. whole plant P or K status were not always extremely high, they were always positive and significant (Figures 2 - 5). Both methods appeared to detect nutrient status of the plants at different fertility levels. This indicates that in all likelihood, whole plant samples can be used for nutrient concentration levels, a fact that is of considerable practical importance, since whole plants are commonly

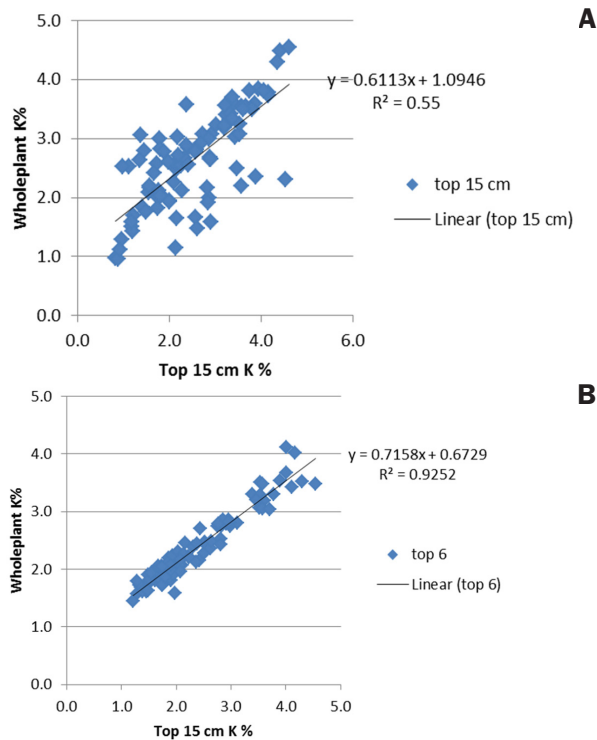

**Figure 4.** Relationship between whole top and top 15 cm sampling protocols for K concentration in alfalfa (All Regions). (A) 2010 and (B) 2011.

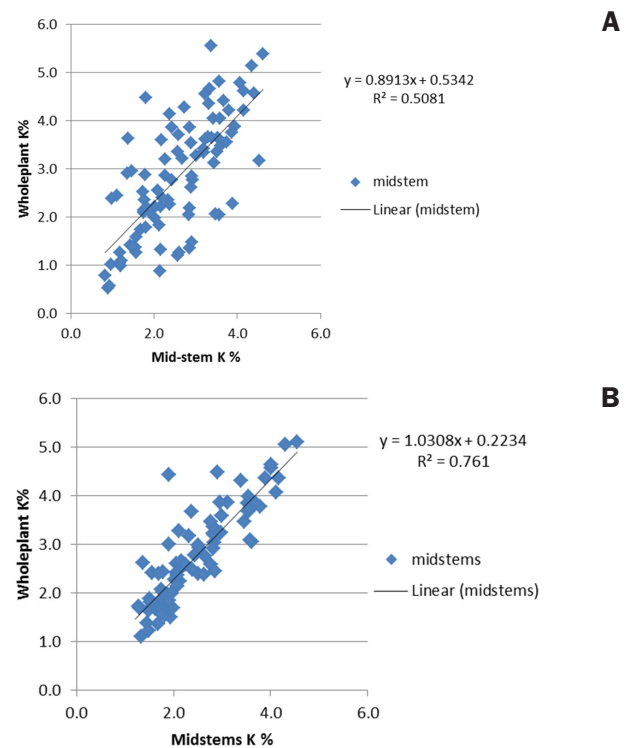

**Figure 5.** Relationship between whole top and mid-stem sampling protocols for K concentration in alfalfa (All Regions). (A) 2010 and (B) 2011.

sampled routinely for forage quality.

Relationship between whole tops and top 15 cm sampling protocols for K concentration is fairly highly correlated as can be seen in data for 2011. Note that data for 2010 showed an outlier in Intermountain Region: IM R2= .11, but highly correlated in Central Valley R2 .85 and in High Desert .95

**Feasibility of Using Bale-Type Samples with Corers to Detect Nutrient Deficiencies.** In general, the correlations between bale-cored samples and standing crop whole plant or mid stem samples vs. soil samples were very high, indicating the potential feasibility of utilizing bale samples for the detection of nutrient deficiencies.

**Influence of Time of Sampling (plant maturity) on nutrient measurements in alfalfa.** One of the key impediments to the standardization of sampling methods in alfalfa is the influence of plant maturity on nutrient concentrations. This is important for either standing crop sampling, bale sampling or with plant fractions.

Concentration of P and K in plants declines significantly

with plant maturity as the plant matures from early bud stage through 10% bloom stage. This change in nutrient concentration has not been adequately accounted for in previous guidelines developed for alfalfa tissue testing. For P analysis, all three methods (whole plant, top 6" and stem) provide similar (parallel) results, but with different average concentrations for each method (**Figure 6**).

For potassium concentrations, average levels in 2010 were similar for whole tops and top 15 cm at all maturities, but concentrations in stems were much greater during early growth periods vs. late maturities (**Figure 7**). In contrast, whole tops and mid-stems were more similar in 2011. The decline in potassium concentration with advancing alfalfa maturity was not as linear as it appeared for phosphorus. In general, the potassium concentration declined more dramatically when alfalfa matured from the late bud stage to the 10 percent bloom stage than it did from the early to late bud stage. These results clearly demonstrate that alfalfa maturity must be considered when interpreting alfalfa plant tissue levels for both phosphorus and potassium. Previous guidelines suggested that the concentration was

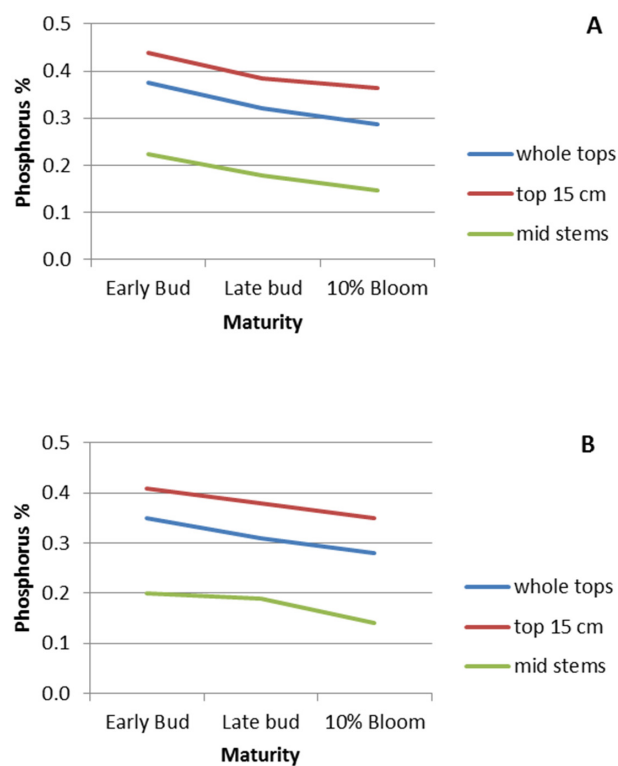

**Figure 6.** Influence of plant maturity on phosphorus concentrations in alfalfa, average of 10 farms, and all cuttings, (A) 2010 and (B) 2011.

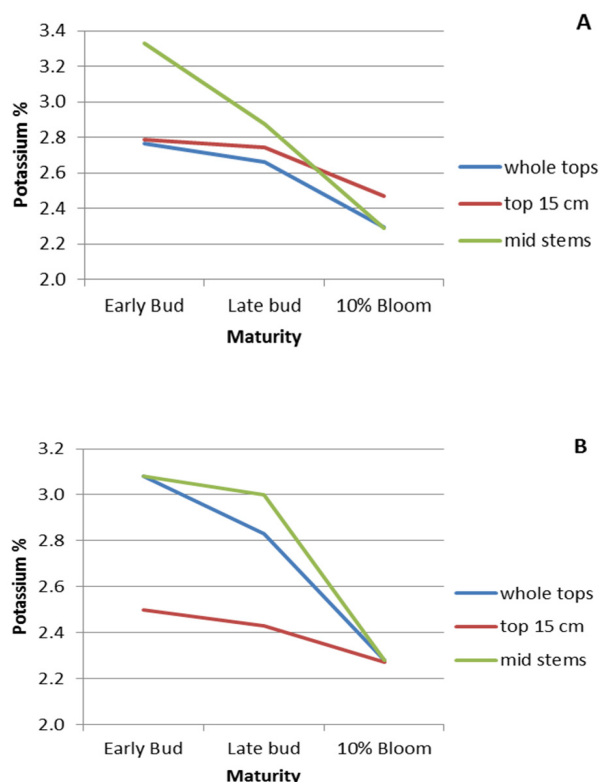

**Figure 7.** Influence of plant maturity on potassium concentrations in alfalfa, average of 10 farms, and all cuttings, (A) 2010 and (B) 2011.



only 10 percent higher in bud stage than in 10 percent bloom alfalfa; however, these data clearly demonstrate that the difference is far greater, approximately a 30 percent difference between 10 percent bloom and early-bud stage alfalfa. Potassium concentration appeared to be slightly more affected by maturity than phosphorus concentration.

Sulfur concentrations were not as greatly affected by stage of development, but there was still some influence (Figure 8). Standardization of sampling method (beyond the current 10% bloom) may be important for any revisions in deficiency tables.

**Utilizing NIRS for detection of deficiencies in Alfalfa.**

Although wet chemistry techniques are often preferred, some labs have proposed utilizing NIRS (an indirect method) for estimating nutrient concentrations. We have run correlations with NIRS-predicted values compared with wet chemistry values for a range of samples in our studies and found relatively high R<sup>2</sup> values. Correlations were 81% (Putnam lab equation) for phosphorus. Additionally, R<sup>2</sup> values of 76% to 78% for K were observed using a commercial lab equation

and the NIRS Consortium equation.

Sulfur % using NIRS did not appear to be highly correlated with wet chemistry from UCD Analytical Laboratory. No current equations at JL Analytical or NIRS Consortium exist for Mo or B, known to be occasionally deficient in some alfalfa production regions such as the Intermountain area.

Sulfur correlations (NIRS vs. chemistry) were lower so it is questionable at this point whether NIRS can be used to estimate the sulfur status of an alfalfa field using tissue analysis. We tentatively conclude that NIRS can be used for early routine detections of phosphorus and potassium nutrient deficiencies (and perhaps for uptake analysis), but caution should be exercised on this issue, since the mechanism for response of NIRS to different nutrient concentrations is not fully understood.

**Phosphorus Response.** A phosphorus rate study was established in the Sacramento Valley in 2010 and continued on the same farm in 2011. The same rates were applied to the same plots in 2011 as 2010. In spite of very low initial soil P levels (Olsen P values 2.5 or less)

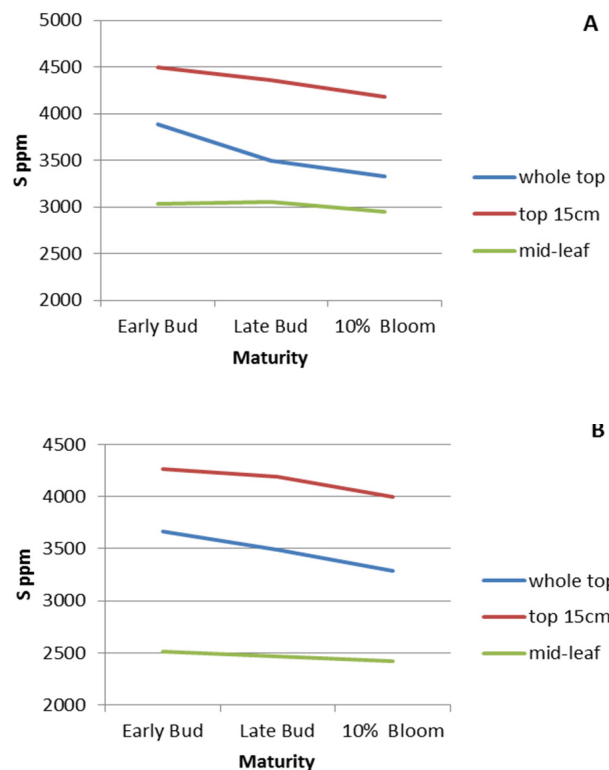

**Figure 8.** Influence of plant maturity on sulfur concentrations in alfalfa, average of 10 farms, and all cuttings, (A) 2010 and (B) 2011.

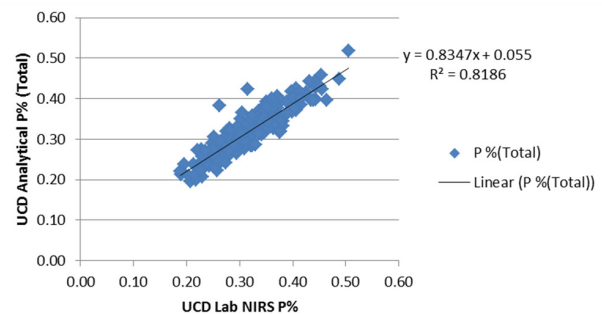

**Figure 9.** Correlation for total P between wet chemistry and NIRS methods. Total P% using wet chemistry was highly correlated with P NIRS using the equation developed in the UCD Putnam lab, 2010-2011.

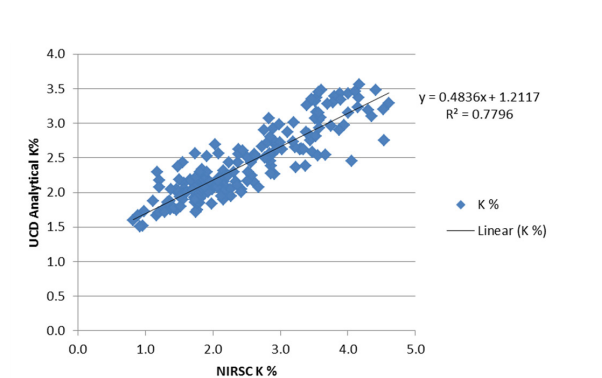

**Figure 10.** Correlation for K between wet chemistry and NIRS methods. K% using NIRS equations from NIRSC are well correlated to wet chemistry values from UC Analytical Lab (2010-2011 data).

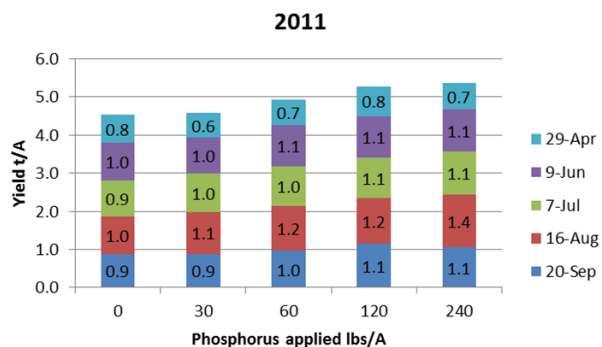
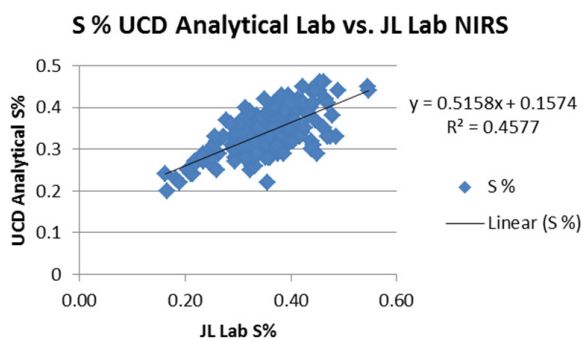
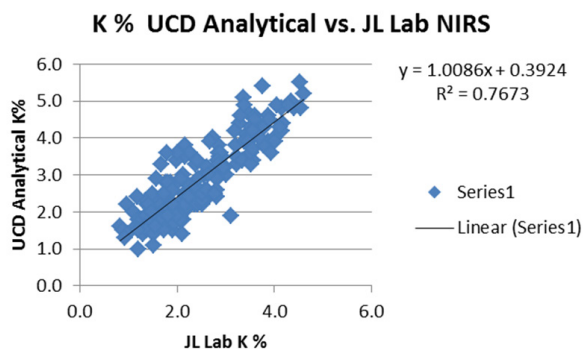

**Figure 11.** Correlation for K and S between wet chemistry at UCD Analytical Laboratory and JL Analytical laboratory NIRS.

**Figure 12.** Yield response of alfalfa to P application on a phosphorus deficient soil, Sacramento Valley, 2010-2011.

**Table 1.** 2012 Preliminary Alfalfa Yield Results

P205 (lbs/a)	t/A	t/A	t/A	t/A	Season total
	30-Apr	4-Jun	9-Jul	8-Aug	
0	1.37	0.92	1.14	0.81	4.24
30	1.66	0.97	1.22	0.87	4.73
60	1.51	0.90	1.21	0.86	4.48
120	1.67	1.03	1.35	0.93	4.98
240	1.74	1.04	1.32	0.92	5.02

<b>Mean</b>	1.6	1.0	1.2	0.9
<b>CV %</b>	9.8	10.2	9.8	6.5
<b>LSD (p=0.05)</b>	0.2	0.2	0.2	0.1

we saw little yield response to P applications the first year (**Figure 12**), but second year response was statistically significant (also true for the first 4 cuts of 2012). Overall yield levels at this site were low, suggesting additional soil factors limiting yield such as drainage and aeration on the heavy clay soils in Western Yolo County.

**Potassium Response.** Alfalfa yield responded dramatically to K rates at the Intermountain site in 2011 (**Figure 13**), results similar to 2010 (data not shown). The total yield increase for the season was greater than 1.5 tons per acre from the lowest (0) to 240 lbs/A  $K_2O$ , although no additional increase in yield was seen over 240 lbs./A  $K_2O$ . This is a typical yield response curve for applied fertilizer. These data together with plant tissue values and subsequent field trails will be used to establish critical values for whole plant tissue levels.

## CONCLUSIONS

Although the final 2012 season has yet to be completed, we can discuss several conclusions at this point. It is clear that utilization of whole plant and bale samples for detection of P and K deficiencies may be quite helpful as a practical method to monitor deficiencies of these nutrients, but different concentration values must be used for whole plant vs. top 6" sampling methods or

when fractionating the plant into different parts for analysis. Plant stage of development has a large influence on the nutrient concentrations, especially for phosphorus and potassium. Therefore, different threshold values will be required to account for plant growth stage at the time of sampling. The importance of P and K fertilizers on deficient soils was apparent from field studies. It is likely that NIRS methods can be useful for early detection of nutrient deficiencies, especially phosphorus and potassium. Since many growers routinely analyze their alfalfa hay for nutritional quality using NIRS, this may be a simple method to evaluate the need for supplemental fertilizer. However, an initial NIRS analysis should likely be followed up with more vigorous field testing to confirm the nutritional status of the field. It was apparent that alfalfa tissue testing protocols remain simple to use and sufficiently accurate so that nutrient analysis can become a routine component of forage quality testing.

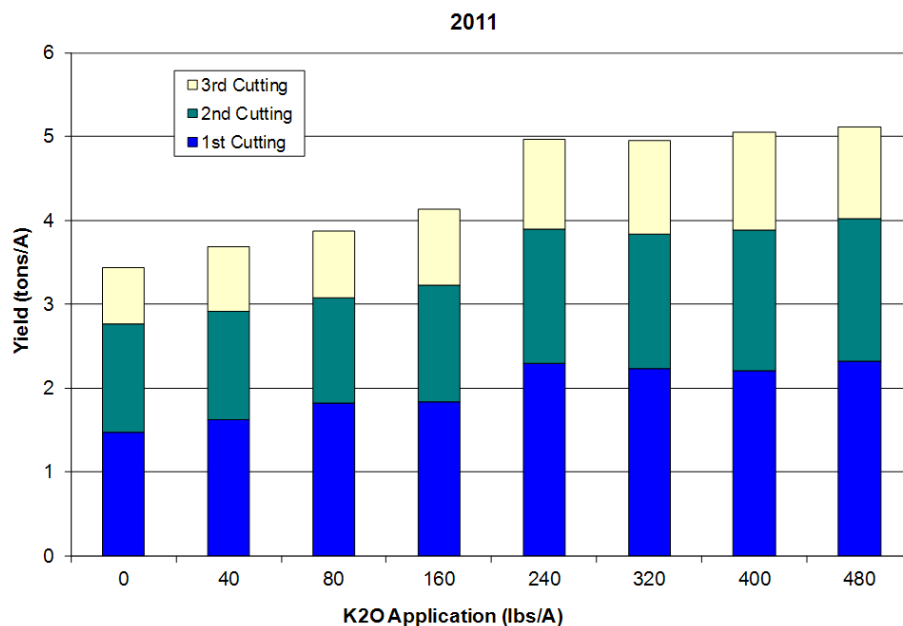

**Figure 13.** Alfalfa Response to Potassium Applications, Siskiyou County Trial, 2011.

# Relationship of Soil K Fixation and Other Soil Properties to Fertilizer K Rate Requirement

## PROJECT LEADER

**Stuart Pettygrove**  
Cooperative Extension Soils  
Specialist  
Dept. of Land, Air & Water  
Resources, University of  
California  
One Shields Avenue  
Davis, CA 95616,  
(530) 752-2533  
gspettygrove@ucdavis.edu,

## CO-INVESTIGATOR

**Randal J. Southard**  
Professor of Soil Science  
Soil Morphologist in the  
Agricultural Experiment Station  
Department of Land, Air &  
Water Resources  
University of California  
One Shields Avenue  
Davis, CA 95616  
530-752-0233  
rjsouthard@ucdavis.edu

## RESEARCH ASSOCIATE

**Gordon Rees**  
Dept. of Land, Air & Water  
Resources  
University of California  
One Shields Avenue  
Davis, CA 95616  
glrees@ucdavis.edu

## INTRODUCTION

Soils of the Central Valley and bordering uplands display a wide range in the properties that determine K fertilizer requirements. Soil K fixation, which is associated with persistent crop K deficiencies, is found in some soils on the east side of the Central Valley that are derived from granitic parent material and contain the silicate layer mineral vermiculite. During the past 40 years, UC researchers have demonstrated the significance of K fixation for cotton and processing tomato production in the Central Valley (Miller et al., 1997; Hartz et al., 2008). In a UC field experiment (Cassman et al., 1989), 86% of the 1540 lb K<sub>2</sub>O/acre applied in a 3-yr period was fixed beyond extraction by NH<sub>4</sub><sup>+</sup>, and cotton plants remained marginally deficient.

We expanded on previous UC research by investigating the relationship between soil mineralogy and K-fixation behavior in San Joaquin Valley soils used primarily for cotton production. Important findings were the dominant role of silt and fine sand fractions in K-fixation in soils in our study that were derived from Sierran granites (Murashkina et al. 2007b) and the observation that some soils that contain little vermiculite fix K, probably due to the presence of tetrahedrally substituted smectite (Murashkina et al. 2008). More recently, we have identified soils with high K fixation potential in winegrape vineyards in the Lodi district. Research supported by the Lodi Winegrape Commission is in progress to determine whether higher rates of K fertilizer are needed on K-fixing vineyard soils in that district than on non K-fixing soils.

Although several UC researchers have examined K fertilizer responsiveness in K-fixing and non K-fixing soils (Cassman et al., 1990; Cassman et al., 1992; Gulick et al., 1989), additional work is needed to develop practical laboratory methods for determining the K fertilizer requirements of such soils. We have developed a 1-hr. incubation method for measuring soil K fixation potential (Murashkina et al., 2007a). Other researchers have shown that a modified version of an older test -- sodium tetrphenyl boron, NaBPh<sub>4</sub> -- is useful for estimating the portion of fixed K that is plant-available (Cox et al., 1999). To be useful to growers in California, these tests must be correlated with K fertilizer response. In research funded by the California Department of Food & Agriculture Fertilizer Research & Education Program, we are using soils previously collected from the Lodi winegrape district and San Joaquin Valley cotton fields to determine whether our regional model categories (O'Geen et al. 2008) are informative with respect to K fertilizer requirement and whether the two analytical procedures described above predict the rate of K required to achieve sufficiency levels.

## OBJECTIVES

1. Determine the rate of K fertilizer required to achieve sufficiency levels (yield not K limited) in both K-fixing and non K-fixing soils.
2. Relate K fertilizer responsiveness of soil profiles for regional model categories (O'Geen et al., 2008). The model groups soils by K fixation potential, landscape location, and geology.



3. For the 1-hour K-fixation potential soil method, determine the effect of sample wetting and drying and sequential K-additions.
4. Provide research summaries and K fertilization recommendations for K-fixing soils to crop management professionals, analytical laboratories, and growers.

In this summary, experiments directed to Objective 3 are described.

## DESCRIPTION

### Soils and Treatments

For experiments described here, we used 24 soil samples collected earlier from two cotton fields and four wine grape vineyards in the San Joaquin Valley of California. Samples had been screened to 2 mm and stored air-dried. Fields with a history of large K fertilizer

applications were excluded from the study. Selected soil properties are shown in **Table 1**. Samples (360 g) were mixed with KCl in 90 mL water at a rate of K equal to the previously measured K fixation capacity shown in **Table 1**. Samples were incubated moist at ~21 °C. Forty-gram subsamples were removed at 1, 2, 4, 8, and 16 days and analyzed in triplicate both at existing moisture content and after air drying. Additional samples from the Armona loam were treated with four cycles of wetting and air drying after the initial application of K and were analyzed after each drying cycle. Another experiment was run by adding K equal to the CEC of the soil samples (a symmetry amount) in the same fashion as above, with 1 day of incubation followed by air drying and analysis.

### Soil Analytical Procedures

#### K fixation potential (Murashkina et al., 2007a) (Kfix).

Soil K fixation potential procedure: Three g soil samples were shaken in 30 mL of 2 mM KCl for 1 hr.

**Table 1.** Selected properties of soils used in this study.

Code/soil/classification	Depth cm	CEC	NH OAc-K initial	K fix initial
		cmol (+)kg <sup>-1</sup>	mg kg <sup>-1</sup>	mg kg <sup>-1</sup>
<b>Archerdale clay loam</b> <i>Pachic Haploxeroll</i>	9-28	28.8	113	19
	28-46	28.4	123	42
	110-135	26.1	119	289
<b>Bruella sandy loam</b> <i>Ultic Palexeralf</i>	0-12	11.8	65	235
	12-30	11.0	45	377
	30-44	9.2	32	259
	60-79	21.2	67	208
	79-100	23.2	53	231
<b>Columbia sandy loam</b> <i>Aquic Xerofluvent</i>	7-41	16.5	67	243
	41-61	18.7	49	348
	61-96	10.8	45	248
	96-135	13.0	36	318
<b>Guard clay loam</b> <i>Duric Haplaquoll</i>	20-40	14.5	63	422
	40-60	16.2	79	500
	80-100	16.4	52	404
	100-120	21.5	50	503
	120-140	16.3	34	450
<b>Armona loam</b> <i>Fluventic Endoaquoll</i>	0-10	22.2	59	384
	10-50	19.7	78	564
	50-100	13.9	48	740
	100-120	29.9	92	475
<b>Gepford clay</b> <i>Typic Natraquert</i>	0-12	30.8	169	63
	12-56	30.4	102	267
	56-95	28.1	104	111

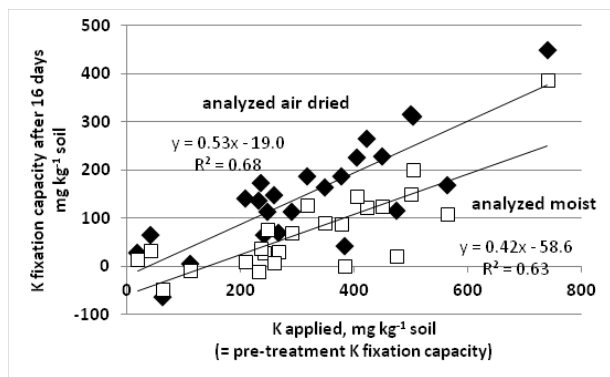

**Figure 1.** Change in soil K fixation capacity following KCl application. Samples are described in Table 1. Samples were incubated moist for 16 days following K application, then analyzed without drying (squares) or after air drying (diamonds). Applying K to samples in amounts equal to initial Kfix reduced K fixation, but not to zero.

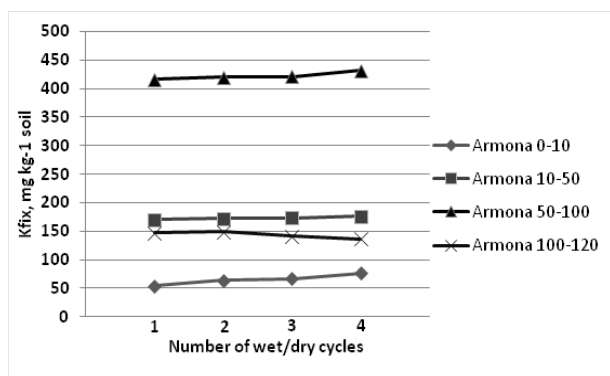

**Figure 2.** Kfix values for the Armona loam soil after 1, 2, 3, and 4 cycles of wetting and drying. Soil Kfix did not change significantly with additional wet/dry cycles.

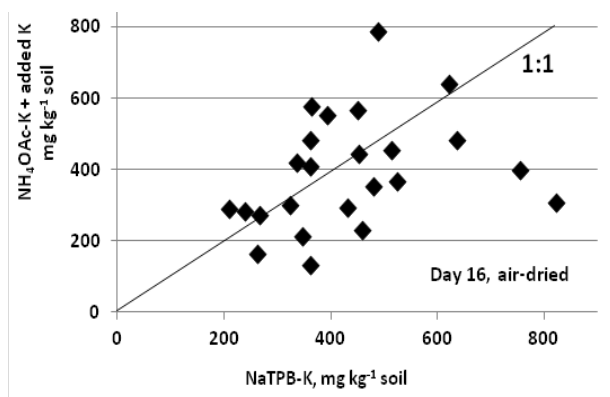

**Figure 3.** NaTPB-extractable K vs. previously measured (initial) NH<sub>4</sub>OAc-extractable K + K added in treatment (Day 16, air-dried). Most TPB-K levels after drying were lower than [Initial TPB-K + added K], indicating that some of the added K was not only fixed but also removed from the pool of plant-available K.

followed by extraction for 30 minutes with 10 mL 4M NH<sub>4</sub>Cl. Following centrifuging, K in solution was measured by flame emission using an atomic absorption spectrophotometer. K fixation potential was calculated as the difference between a without-soil blank and the measured K solution concentrations in triplicate subsamples. Results are expressed as mg K fixed per kg soil, but can also be expressed as percent of initial solution K removed from the solution by fixation.

**Ammonium acetate-extractable K (Soil Survey Staff, 2004) (NH<sub>4</sub>OAc-K).** 2.5-3 g soil were saturated and extracted overnight with 1 M NH<sub>4</sub>OAc (pH 7) using a mechanical vacuum extractor, and K was determined by flame emission spectrometry.

**Sodium tetraphenylboron-extractable K (Cox et al. 1996, 1999) (TPB-K).** One gr. of soil was extracted without shaking for 5 minutes with 3 mL of extracting solution (0.2 M NaTPB + 1.7 M NaCl + 0.01 M EDTA). Twenty five ml. of quenching solution (0.5 M NH<sub>4</sub>Cl + 0.11 M CuCl<sub>2</sub>) was then added, and samples were heated, then boiled for 30-45 minutes to dissolve the resulting precipitate. Samples were shaken by hand and then filtered. Solutions were analyzed for K by flame emission using an atomic absorption spectrophotometer.

## RESULTS AND DISCUSSION

**Effect of incubation time.** K fixation potential values (Kfix) were independent of the length of incubation. This suggests that essentially all changes to the fixation potential of these soils after the addition of K takes place in the first 24 hours. NH<sub>4</sub>OAc-K and TPB-K values behaved inconsistently. Some, but not all, samples had an apparent slight downward trend in NH<sub>4</sub>OAc-K with time, and other samples showed an apparent slight upward trend in TPB-K with time.

**Effect of air drying.** Kfix values increased after air drying for all soil samples analyzed (Figure 1). Air drying did not have a consistent effect on NH<sub>4</sub>OAc-K. The rise in potential to fix K with drying may not realistically take place under field conditions, where complete air drying (especially at depth) is never likely to occur. This result is interesting, however, in that it may provide clues to the mechanisms involved in K fixation.

**Effect of wetting and drying cycles.** Additional cycles of wetting and air drying did not significantly affect the values of Kfix, NH<sub>4</sub>OAc-K, or TPB-K, as shown in Figure 2. The changes in K fixation potential that were produced by a single drying event were not enhanced by additional drying cycles.

**Results of symmetry addition of K.** The addition of K equal to the CEC of the soil provided several times more K than the initial Kfix amount, and completely saturated

the soil samples with K. By running the Kfix procedure on these samples, and comparing the excess K released to the amount of K added, we were able to determine an approximate maximum absolute value for the K fixation potential of the soils. The proportion of this symmetry amount of K added that was fixed by the soil ranged from 5% for the Gepford clay (0-12 cm) and 37% for the Armona loam (50-100 cm), meaning that even with extremely high rates of K application, a significant proportion of that K was fixed in some soils.

Additions of K to K-fixing soils results in a new distribution of K across the various pools of soil K. Some of the added K remains exchangeable, some becomes non-exchangeable, but still plant available, and some is fixed in a non-plant-available form (**Figure 3**). This information, along with our results from an expanded exploration of these effects, will be useful in understanding the fate of fertilizer K applied to K-fixing soils, and in developing recommendations for overcoming the negative impacts of K fixation and K deficiency on crop yields.

## LITERATURE CITED

- Cassman, K.G., D.C. Bryant, and B.A. Roberts. 1990. Comparison of soil test methods for predicting cotton response to soil and fertilizer potassium on potassium fixing soils. *Communications in Soil Science and Plant Analysis* 21: 1727-1743.
- Cassman, K.G., B.A. Roberts, and D.C. Bryant. 1992. Cotton response to residual fertilizer potassium on vermiculitic soil: organic matter and sodium effects. *Soil Science Society of America Journal* 56: 823-830.
- Cassman, K.G., B.A. Roberts, T.A. Derby, D.C. Bryant, and S.L. Higashi. 1989. Soil potassium balance and cumulative cotton response to annual potassium additions on a vermiculitic soil. *Soil Science Society of America Journal* 53: 805-812.
- Cox, A.E., B.C. Joern, S.M. Brouder, and D. Gao. 1999. Plant-available potassium assessment with a modified sodium tetraphenyl boron method. *Soil Sci. Soc. Am. J.* 63:902-911.
- Cox, A.E., B.C. Joern, and C.B. Roth. 1996. Nonexchangeable ammonium and potassium determination in some Midwestern soils using a modified sodium tetraphenylboron method. *Soil Sci. Soc. Am. J.* 60:114-120.
- Gulick, S.H., K.G. Cassman, and S.R. Grattan. 1989. Exploitation of soil potassium in layered profiles by root systems of cotton and barley. *Soil Sci. Soc. Am. J.* 53:146-153.
- Hartz, T., G. Miyao, J. Mickler, M. Lestrangle, S. Stoddard, J. Nunez, and B. Aegerter. 2008. Processing tomato production in California. Publication 7228. Division of Agriculture and Natural Resources, University of California, Oakland.
- Miller, R.O., B.L. Weir, R.N. Vargas, S.D. Wright, R.L. Travis, B.A. Roberts, D.W. Rains,
- D. Munk, D.J. Munier, and M. Keeley. 1997. Cotton potassium fertility guidelines for the San Joaquin Valley of California. Publication 21562. Division of Agriculture and Natural Resources, University of California, Oakland.
- Murashkina, M. A., R.J. Southard, and G.S. Pettygrove. 2007a. Potassium fixation in San Joaquin Valley soils derived from granitic and nongranitic alluvium. *Soil Sci. Soc. Am. J.* 71:125-132.
- Murashkina, M. A., R.J. Southard, and G.S. Pettygrove. 2007b. Silt and fine sand fractions dominate K fixation in soils derived from granitic alluvium of the San Joaquin Valley, California. *Geoderma* 141:283-293.
- Murashkina, M. A., R.J. Southard, and R. Shiraki. 2008. Estimation of vermiculite content using rubidium-fixation procedures in four California soils. *Soil Sci. Soc. Am. J.* 72:830-837.
- O'Geen, A.T., S. Pettygrove, R.J. Southard, H. Minoshima, and P.S. Verdegaal. 2008. Soil-landscape model helps predict potassium supply in vineyards. *California Agriculture* 62:195-201.
- Soil Survey Staff. 2004. *Soil Survey Laboratory Methods Manual – Soil Survey Investigations Report No. 42. Version 4.0.* USDA-NRCS. Lincoln, NE.

## ACKNOWLEDGEMENTS

K fixation potential and cation exchange capacity values in **Table 1** were provided by Hideomi Minoshima, graduate student in Soils & Biogeochemistry, UC Davis. Work was supported by a grant to UC Davis from the Lodi Winegrape Commission.

# Nitrogen Research & Groundwater Management Education Program

## PROJECT LEADER

### **Renee Pinel**

President/CEO  
Western Plant Health Association  
4460 Duckhorn Dr., Ste. A  
Sacramento, CA 95834  
(916) 574-9744  
reneep@healthyplants.org

## PROBLEM

The Central Valley Regional Water Board (CVRWB) is promulgating regulations for the management of nutrient impacts on groundwater. Of particular interest is the role of nitrogen fertilizer in groundwater. Growers and members of the plant nutrient industry continue to be under pressure to demonstrate sound decision making in their nutrient application decisions. Seminars and conferences have proven to be effective in delivering new Best Management Practices research. However; despite the need to develop consensus on this issue, the fertilizer industry and growers have not come together to effectively identify what is taking place in the field, or to coalesce on what additional steps can or should be taken in an environmentally safe and agronomically sound program for commercial agriculture, to satisfy concerns of the regulatory community with interests in water quality protection.

## PROJECT OBJECTIVES

The objectives in outreach is to provide this information to as wide an impacted audience as possible, and to assure BMP projects identified through the FREP project do not present unidentified costs or impacts to growers. It is also to facilitate discussion with the CVRWB, industry, and grower groups via scientifically sound programs that meet the needs of grower groups and the regional water board. The project will as a result lessen pressure and frustration of all sides by providing a solution to an identified problem at a minimal cost to all involved. The ultimate objective through this effort and outreach is this process will establish a basis from which water boards and their staffs feel their regulatory requirements are recognized and maintained, and future approvals of nutrient BMPs can be deferred to CDEA for approval.

All aspects of this project will take place on an ongoing basis. Interim task projects related to identification of steps to allow the use of “Farm Water User Plans” will part of ongoing discussions with CVRWB staff. Additional interim task projects will be the reporting of nitrogen research and BMPs identified, and work with outside organizations and water board staff. Project managers will provide interim reports on the status of the project at the end of six months and the end of the first year.

## PROJECT UPDATE

The first step in facilitating the use of “Farm Water User Plans” was receiving approval from the CVRWB. In order to facilitate discussions with CVRWB on the adoption of the use of BMPs as part of a regulatory program to address nitrates in groundwater, WPHA joined the Central Valley Salts Coalition (CVSC). The CVRWB has tasked the CVSC with identifying a strategy for managing nitrates in groundwater, and specific components of an acceptable nitrate management program. Participation in this program allows WPHA to meet on a regular basis with CVRWB staff and agricultural grower coalitions. WPHA is one of only three agricultural associations who participate as a member of this group. WPHA meets regularly with other agricultural associations to apprise them of the status of the program, and to receive their input on issues under discussion by the Coalition. The WPHA serves on the Executive Board of the CVSC, which is made up of CVRWB members and executive officers, staff and other state and federal agency staff members who have a regulatory interest in nitrates and salts in groundwater. As well as serving on the Executive Committee, WPHA serves on the BMP Committee, and Technical Issues Committee. WPHA staff attends the CVSC board meeting, which



meets every month. In addition, WPHA participates in conference calls for the Executive Committee, BMP Committee and Technical Issues Committees. When the CVSC began meeting in 2011, CVRWB staff was recommending the use of numeric limits for the regulation of nitrates in groundwater. Through extensive discussions and submission of technical information explaining the complexities of managing nitrates in groundwater the BMP committee recommended to the CVSC board that BMPs was the more practical direction for a regulatory program related to nitrates in groundwater. From this recommendation the full CVSC recommended the use of BMPs as a regulatory program. Over the past year, and after the acceptance by CVSC to utilize BMPs, the CVRWB has also approved the use of BMPs as part of a compliance program to implement the Agricultural Irrigated Lands Program.

Still to be addressed by CVSC and CVRWB is identification of appropriate BMPs. WPHA meets regularly with agricultural associations to discuss BMPs and to help them understand what will be required for CVRWB to approve a BMP. Through discussions with waterboard members and management via CVSC, it is understood that an acceptable BMP most address environmental benefits of a BMP and not just agronomic benefits. At the same time, grower groups must be able to justify the use of a BMP to their growers from an agronomic perspective if there is to be a realistic level of adoption for a BMP. To do this, WPHA continues to meet and explain to growers that acceptable BMPs must be developed or reviewed and approved by a university researcher, preferably from the California State University of University of California system. The BMP must identify the environmental benefit of the BMP, and will also identify the agronomic benefit for growers.

As part of this process, WPHA is meeting with national associations to discuss California needs, and to develop or refine how national nutrient programs to be useable for California regulatory needs. As part of this, WPHA is partnering with the International Plant Nutrient Institute to identify through our Soil Improvement Committee, BMPs for growers and utilization of TFI's 4R program for BMP development.

As part of the acceptance of the use of BMPs by the CVRWB, it was determined that growers must identify what level of BMP reporting is necessary. WPHA has been working with our Soil Improvement Committee and grower coalitions in developing this tool. Over the past year, an assessment tool, a "Nitrate Budget" has been under development. This tool will act as a screen documenting how growers are making their nitrogen management and application decisions, eliminating growers who are in areas that do not require a greater level of reporting from having to develop more comprehensive plans, and demonstrate

to waterboard staff the decision making process that a grower utilizes in planning their nitrogen use decisions. The "Nitrate Budget" is being finalized by the WPHA Soil Improvement Committee and reviewed by use by grower groups. Again, the development of this report has been an ongoing collaborative process between WPHA and the grower community. WPHA is also meeting with agricultural associations explaining the use and regulatory benefit of the budget report, for acceptance and use by those groups as policy making entities.

The acceptance of these efforts with agricultural groups is necessary for widespread acceptance by the grower community. CDFG is developing a web-based library of BMPs. WPHA supports this effort and as part of our interaction with grower coalitions and agricultural associations explains the importance of this effort and why production groups should support this effort. While it would seem that this effort would naturally be supported by agriculture, concerns about a CDFG listing of BMPs becoming regulatory mandates is an issue that is of ongoing concern by agricultural associations, and WPHA addresses these concerns as part of our overall strategy in identifying available BMPs for regulatory acceptance.

WPHA holds ongoing meetings with agricultural groups and the fertilizer industry. Over the past year, WPHA President Renee Pinel has spent on average, 1 day per week directly meeting with either agricultural groups or industry groups discussing the identification of BMPs and BMP reporting. WPHA meets on a monthly basis with a variety of commodity groups in the Central Valley, as well as conference calls on a bi-weekly basis with the leaders of these groups. Pinel also attends grower coalition meetings on a monthly basis for Northern California grower coalitions and County Farm Bureaus. Through these discussions, while there is still great reluctance and resistance to growers having to do more reporting, that programs that WPHA has participated in are the preferred programs of grower groups.

## SUMMARY

Because of the complexity of the development of nutrient reporting regulations, we have found that it is not practical to try to complete the various goals of this program in a linear or step by step process. Instead, we have adopted a comprehensive process addressing various components of the FREP project as appropriate. WPHA is very pleased that as a result of this strategy, that they key components for the use of BMPs has been successfully achieved. I.e., the CVRWB approving the use of BMPs as part of a regulatory program, the use of a simple "Nitrate Budget" to simplify and prioritize reporting levels for growers, how to utilize a BMP in a regulatory program, and to begin to identify appropriate BMPs for use in a regulatory program.

# California Certified Crop Adviser Educational Project

## PROJECT LEADER

**Dan Putnam**  
UCCE Specialist  
Department of Plant Sciences  
One Shields Ave. MS # 1  
University of California  
Davis, California  
95616-8780  
530-752-8982  
dhputnam@ucdavis.edu

## COOPERATOR

**Terry W. Stark**  
President/CEO  
California Association of Pest  
Control Advisers (CAPCA)  
1143 No. Market Blvd. Suite 7  
Sacramento, CA 95834  
(916) 928-1625 ext 202  
(916) 928-0705 fax  
terry@capca.com

## COOPERATOR

**Steven Beckley**  
Principal  
S. Beckley and Associates  
P. O. Box 8563  
Woodland, CA 95776  
(916)539-4107  
sbeckley@aol.com

## INTRODUCTION

There are hundreds of crop advisers in California who make recommendations on a regular basis on fertilizers and crop management. The California CCA educational project has as its goal to provide a needs-based mechanism for the educational credits and certification of qualified individuals deliver science-based recommendations to California farmers. Fertilizers are a key component of crop production in California. The California Certified Crop Adviser (CCA) program has established its position as a key educational asset in public education related to fertilizers, soil resource management, and crop production technologies.

The CA-CCA effort is to promote the educational goals of FREP with regard to soil, water, crop and nutrient resource management and to enhance the viability of Crop Advisor Certification over time, so that fertilizers are better managed. The audience for the educational and certification outreach will be fertilizer applicators, crop protection companies and licensed pest control advisers in anticipation the sum-total improvement in knowledge among practitioners in CA is realized. The CA-CCA program is one of the most important mechanisms for assuring expertise and proficiency of these individuals in determining fertilizer practices in California. As such it is an integral component fulfilling the FREP educational objectives.

The CCA program tests potential advisers using standardized, scientifically based exams, sets professional requirements, and provides certification for continuing

education. Leadership is provided by an all-volunteer board consisting of CCA members, UC Cooperative Extension, NRCS and other agencies participating. The program continues training and cosponsoring seminars and other learning opportunities. It has initiated events for conventional fertilizer practices as well as organic. Since CCA certification is (mostly) not required by state regulations or other entities, outreach efforts are required to maintain the strength, professionalism, and integrity of the program. As a result, the Fertilizer Research and Education Program (FREP) funding has provided valuable outreach components to increase membership and maintain the high standards of the program, in addition to the nuts and bolts of running the program.

The Ca-CCA program has developed incentives for growers to utilize the skills and knowledge of CCAs in their production operations as the state becomes more and more active with regards to environmental regulations. Specifically, CCA has been very active with certification for development of nutrient management plans (NMPs), which have been driven largely by permitting and public agencies.

Good management decisions provide economic opportunities contained in good fertility management, and prevent water quality or air quality contamination from sub-optimum agricultural practices. The ability to provide advice to make rapid, intelligent and scientifically sound management decisions prevents California farmers from over applying fertilizers or manures.

## OBJECTIVES

The following are the objectives outlined in the CCA Educational project:

1. Provide responsible program administration, leadership and CCA awareness for CA fertilizer industry.
2. Strengthen CA CCA program certifications through improved communications, marketing/recruitment techniques identifying the value for having a CCA certification.
3. Implement a workable plan towards sustainability as an organization.
4. Efficiently administer the CA CCA program on a day to day basis providing services to ICCA, CDFA/FREP and all CA CCA certificate holders or candidates.
5. Project management evaluation and deliverables will be viewed at each CA CCA Board meeting and shared with Project Manager and CDFA representative.

## DESCRIPTION OF ACCOMPLISHMENTS AND ACTIVITIES

The CCA program currently has 612 individual members, which is up substantially from the 535 members in 2011. Additionally, 157 individuals took the exam in August of 2012, which is a record for the August exam. All of these figures are indicative of the growing success of the CCA program, the FREP-funded outreach program, as well as the growing need, driven by regulation, of CCA certification and training.

The challenge is to identify the value of obtaining and maintaining a Certified Crop Advisors' certification and the value the certification brings to them as well as the value of the expertise they enjoy with the judicious use of fertilizers (and other resources) in California's crop production systems. Regulatory impacts being placed on production agriculture and specifically the mitigation of nitrate contamination in water will require a much broader educational awareness than just agricultural advisors. The CA CCA can play a positive role in assisting the producer obtain their maximum production with economic gains and be compliant with all regulatory requirements.

The California Certified Crop Advisor (CA CCA) Program is a voluntary, non-profit organization that represents professionals who have pursued an educational pathway and have tested to hold a certification to provide nutrient management recommendations to growers. A CCA certification is



**Figure 1.** CCA Board Member Allan Romander has assisted at signing up exam participants at outreach meetings throughout California.



**Figure 2.** CCA Training Session for prospective CCAs, January, 2012.



**Figure 3.** CCA Chair Sebastian Braum meets with Harry Cline, editor, Western Farm Press during a fertilizer demonstration field day. The board's ability to work with media outlets enhances the visibility of the CCA program.



a recognized asset in assisting both Federal and State government agencies tasked with the stewardship of the state's natural resources. The program is in the first six months of addressing its stated objectives. CCAs are a key component as an asset in public education related to fertilizers, soils resource management and crop production. A positive outcome has been the awareness achieved to acknowledge the role of the CCA in fertilizer management and the overall contribution to the sustainability of the industry and the educational goals of FREP.

### Several Accomplishments during 2011-2012

**Objective 1): Provide responsible program administration and CCA awareness for CA fertilizer. Tasks 1, 2, 3, 4 & 5 seek discussions with fertilizer companies, increased working relationship with affiliated fertilizer organizations, improved awareness brochures, outreach to diversified representation for BOD & provide program evaluations respectively.** The knowledge of a CCA is essential to production agriculture when striving to be compliant with residue levels in the surface and ground water systems to mitigate nitrate contamination. CA CCA members engaged in several agricultural waiver related educational and nutrient management seminars to assist in program content to articulate to growers and public officials practical remedies to nutrient management concerns. CA CCA Directors have engaged in numerous water regulatory advisory meetings for Central Valley and Central Coast discussions.

CA CCA directors, CAPCA & S. Beckley & Associates have engaged in nitrate discussions with CDFA Secretary, CA Water Board Chairman and CDFA fertilizer staff during reporting period to identify best management practices and educational goals to be considered in improving total industry knowledge in addressing nitrate issues.

CAPCA continues to provide the professional management services guaranteeing responsible program administration and support to volunteer CA CCA directors for program leadership. CAPCA ED has provided educational support and leadership to CCA program and will partner with CDFA/FREP to implement educational outreach to all agricultural venues and general public where identified. CA CCA BOD has added two diversified CCAs to the board and is continuously aware of program evaluation.

**Objective 2): Strengthen CA CCA program certifications through improved communications. Tasks 1, 2, 3, & 4 emphasize benefit of CCA credential, professional CEU development for nutrient challenges, recruitment of new CCAs & retention of current CCAs respectively.** The CA CCA program has demonstrated a positive growth trend

due to awareness efforts. The CA CCA Board continues to offer multi exam study seminars and on-line test practices that are extremely helpful to candidates. The current number of CA CCAs is 601 through June 30, 2012. The February 2012 exam had 60 International exam and 58 CA exam candidates pass out of 103 candidates and the August exam has 157 candidates registered to test. The message of possessing a nutrient credential is positive.

During this reporting period all goals identified in the task were accomplished and supported by CCA volunteers. The CCA leadership prioritized the venues to attend and market the CCA program and materials. CAPCA *Adviser* Magazine contained a minimum of one article per edition and included one to two advertisements per edition using CCA approved ads. CAPCA staff supported the requests of the CCA Board in executing an E-Newsletter as an informational tool and provided web site messaging as well as the maintenance and "freshening" of the CCA web site as necessary. Social media techniques were utilized to message fertilizer regulatory issues, meetings and CCA exams. During interim reporting period, CAPCA staff reviewed and processed 177 CEU applications.

WPHA and CAPCA have included the CCA outreach/awareness effort to be included in California University Student dinners and Pathway to PCA respectively whereby the message is conveyed to students to choose a career in agronomy, plant health and seek a professional license/credential to validate their expertise. CA CCA volunteers have increased the appeal of becoming a CCA and the BOD has continued to encourage continuation of credentials for those CCAs challenged to obtain hours or pay their annual dues.

**Objective 3): Implement a workable plan towards sustainability as an organization. Tasks 1, 2, & 3 directs CA CCA program to examine alternative revenue sources and to strengthen the CCA program.** The immediate outcome to accomplishing the goal is to strive to increase the number of CCAs seeking a credential. CA has demonstrated excellent growth over the rest of the US and has experienced huge increases in candidate taking the exams. This growth in certifications will enable the CA CCA program to be less dependent on FREP. As CA regulatory agencies increase oversight requirements of nitrate contamination, the value of having a CCA certification to assist producers becomes more evident. The educational awareness regarding fertilizer/nutrient management in California will only grow as more regulations are anticipated and a partnership with FREP to accomplish these requirements is in the best interests of both.



**Objective 4): Efficiently administer the CA CCA program on a day to day basis. Tasks 1 and 2 direct the cooperator to support the administration of the CCA program and administer the CA CCA website.** CAPCA as the Contractor of the FREP grant for University of California provides daily administration for the CEU approval and member communications. The administration of the approved course data is published on the web, print media and E-newsletters to the membership. CAPCA coordinates with ICCA for all announcements regarding CCA CEU record tracking and provides the administration support for the two CCA certification exams and pre-exam prep held in California at as many as five exam site locations. CAPCA staff is constantly answers CCA inquiries and support CEU sponsors.

**Objective 5): Project management evaluation and deliverables.** The UC Principle, Dr. Dan Putnam, reviewed this objective with the CA CCA Board of Directors and stressed the importance of accomplishing the grants goals & objectives while providing necessary oversight. CA CCA Executive Committee along with UC and CDFA FREP representatives will provide the evaluations.

## OUTREACH ACTIVITIES

Meetings involved regional water control board issues(growers & regulators), Ag waiver coalitions, nitrate mitigation concerns-retailers, FREP/CDFA fertilizer mitigation (Secretary & Senior staff), fertilizer company representatives, CCA BOD, Ag media providers, legislative staffs, PCA/CCA CE seminars; CA Ag Teachers Conference and industry association representatives. An average of 5 meetings per month were attended or utilized by CCA board members for outreach activities.

## SUMMARY

The California CCA program invests in the educational and certification infrastructure and outreach necessary for developing long-term basic expertise and competency to meet the challenges of nutrient management for the future. This expertise is embodied in the more than 612 Certified Crop Advisers in California, a large increase from several years ago. CCA has provided training on new issues faced by the state's crop advisors, including organic production, water contamination, and manure management. A record 157 new CCAs took the exam in August, 2012, an indication of the importance of the program. There have been a range of accomplishments over the past year, including increases in membership, educational programs, outreach, and training. The CCA program has expanded its certification program to include nutrient management training for those developing nutrient management plans. The continued success of the California CCA program serves the agricultural industry and the general public by assuring that agricultural practices are environmentally sound and economically feasible. Future steps will include further development of certification for nutrient management expertise and how CCA requirements will mesh with CDFA and Water Board requirements. For more information on the program please see: <http://www.cacca.org/>

# Management Tools for Fertilization of the ‘Hass’ Avocado

## PROJECT LEADER

### **Richard Rosecrance**

Associate Professor  
Plant Sciences  
College of Agriculture  
California State University  
Chico, CA 95926  
(530) 898-5699  
rrosecrance@csuchico.edu

## PROJECT LEADER

### **Carol J. Lovatt**

Professor of Plant Physiology  
Dept. of Botany and Plant  
Sciences  
University of California  
Riverside, CA 92521-0124  
(909) 787-4663  
carol.lovatt@ucr.edu

## COOPERATOR

### **Ben Faber**

UC Farm Advisor  
Coop. Ext. Ventura County  
669 County Square Drive, #100  
Ventura CA, 93003-5401  
(805) 645-1451  
bafaber@ucdavis.edu

## INTRODUCTION

This project focuses on developing best management fertilizer practices to improve nutrient use efficiency (yield per unit input of fertilizer) and reduce environmental pollution related to excessive fertilizer applications. For the ‘Hass’ avocado (*Persea americana* L.) industry of California, fertilization rates and optimal leaf nutrient ranges have been borrowed from citrus for all nutrients except nitrogen (N), zinc (Zn) and iron (Fe). Competition from Mexico, Dominican Republic, Chile, Australia, Peru, and South Africa requires the California avocado industry to increase production per acre to remain profitable. Optimizing fertilization is essential to achieve this goal.

The development of best management fertilizer practices is particularly important for alternate bearing avocado trees, for which most growers use the results of their August-September leaf analyses to replace nutrients used by the current crop. If not managed correctly, trees that are setting fruit in an off year receive more fertilizer than is needed (Lovatt, 2001). Over fertilization with nitrogen can significantly decrease avocado fruit size (Arpaia et al., 1996). Properly timing soil-applied nitrogen can increase yield and fruit size and reduce alternate bearing of the ‘Hass’ avocado.

We believe that the deliverables of this project will increase yield, fruit size and profitability for California’s 6,000 avocado growers, while protecting the groundwater. Information on best management fertilizer practices will be supplied in two formats: 1) graphically – plots will be developed documenting the stage-to-stage (month-to-month) changes in the concentrations of each essential mineral nutrient in vegetative and reproductive

organs for both on- and off-crop trees, and 2) Dynamically – A computer-based fertilizer model will be developed. Computer-based fertilizer recommendations have been successfully adopted by growers for other crops (almond, pistachio, walnut, macadamia, etc.) and should be developed for avocado.

## OBJECTIVES

1. Develop user-friendly phenological timelines reporting biomass accumulation and total nutrient uptake for specific reproductive structures and vegetative components.
2. Develop a computer program that growers can easily use to calculate their own fertilizer recommendations (nutrient, application time and rate) based on tree phenology, crop load, and vegetative growth calculations.
3. Trouble-shoot, and finalize the computer program and make it available on the web. Our computer-based approach involves mathematical data mining, graphic representation of results for ease of use, and development of the computer program.

## DESCRIPTION

The PIs completed the difficult task of quantifying nutrient partitioning during all stages of tree phenology by excavating on- and off-crop avocado trees every two months over two years at Somis Pacific in Moorpark, California. At excavation, trees were dissected into inflorescences, fruit, leaves, green shoots (<½ inches), small branches (½-2 inches), mid-size branches (2-4 inches), scaffolding branches (4-6 inches), wood (> 6 inches), scion trunk, rootstock trunk, scaffolding

roots, small roots and new roots. Total weight of each component was recorded. Sub-samples were washed, dried, ground, weighed and analyzed for nutrient content of 12 essential elements.

A basic phenology and yield-based nutrient model has been developed for avocado using these tree nutrient partitioning data (called Avomodel). Currently, we are expanding the model parameters to produce a more comprehensive model that include factors such as crop load in the current and previous year and nitrogen leaching based on irrigation practices.

## RESULTS AND DISCUSSION

### Development of avocado nutrient fertilization model

Calculating the appropriate rate of fertilizer to apply is a complex process that involves interpretation of leaf and soil analyses, and a range of orchard and site condition factors.

In a typical well-managed orchard with reasonably fertile soil, nitrogen, potassium and zinc are likely to be the only nutrients that need to be applied regularly. Thus, the fertility model developed for this project will include these nutrients. Factors to consider when developing a nutrient fertilization model include:

- Crop load or yield in the current year
- Crop load or yield in the previous year
- Canopy size
- Leaf nitrogen, potassium and zinc levels
- Soil texture

Nitrogen and potassium fertilizer model for the 'Hass' avocado in California, input and output is shown in **Figure 1**. The model is simple to use with minimal inputs

required.

The relationship between avocado yield and nutrient removal in the crop must be determined in order to develop a fertilizer recommendation model. In this case, we used the nutrient removal calculator based on data from Dr. Arpaia and found at the website: (<http://www.avocadosource.com/tools/NutRemCalc.htm>). The model input and output information is presented in **Figure 2**.

It is a common practice in avocado orchards to apply N fertilizer at rates that exceed those required for maximum yield and sustainable production. Over-irrigation, due to a poor irrigation plan can increase the risk of nitrate leaching. Therefore, updated nitrogen leaching factors were recently included in the model. The factor was based on irrigation water applied (percent acre-feet of water applied above required amount) soil type, and the amount of N applied (**Table 1**).

We have adapted the California almond nitrogen model to avocado. The model can be seen at the website: <http://www.csuchico.edu/~rr19>. We are currently evaluating this model for its merits and looking at different ways to improve the model to meet the needs of California avocado growers.

### New additions to the model

**Tree phenology and soil type.** Avocado trees are unique because the fruits can remain on the tree for 15 to 18 months after full bloom (two growing seasons). The tree must support the growing fruitlets and the maturing fruit from the previous growing season. Moreover, both developing and maturing fruit are strong sink for nutrients. Recent modifications to the avocado nutrient fertilization model include:

**Table 1.** Nitrogen leaching factor based on irrigation water applied (percent acre-feet of water applied above required amount) and soil type.

Percent of acre-feet of irrigation water applied above required amount	Percent of leaching Fertile Loam	Percent of leaching Sandy loam	Percent of leaching Sand
0	0	0	0
15	0	0	45
30	15	30	60
45	30	45	75
60	45	60	100
75	60	75	100
100+	85	90	100

**Figure 1.** Nitrogen and potassium fertilizer model for the 'Hass' avocado in California, input (left) and output (right) based on 10,000 lbs./a avocado crop.

### Avocado Nitrogen And Potassium Model

Field Name:  Crop Year:

Area:  Full Bloom Date:

**\*\*\* Crops Information \*\*\*** **\*\*\* Orchard Information \*\*\***

Estimate 2012 Yield:  lb/acre Orchard Tree Age\*:

2011 Crop still on trees:  at 2012 Full Bloom Distance between trees:  ft

Estimate 2011 Yield:  lb/acre Distance between rows:  ft

2011 Crop Harvest:  2012 Canopy diameter:  ft

**\*\*\* Fertilizer Application \*\*\***

Soil type of Orchard:

Fertilizer application method:

**\*\*\* Available N from Field \*\*\***

Acre feet of well water applied per year  feet/acre. \*\* 3.6 feet/acre recommended for SouthCoast area 7 years old orchard.

\*\* 0 % over recommended for water usage. Low leaching risk. Get water usage recommendations

Water Nitrate - Nitrogen (NO<sub>3</sub>-N) concentration\*  ppm (mg/liter).

\*\*\* Organic N \*\*\*

Manure: Last year   tons/acre

Two year prior   tons/acre

Compost:  Amount(tons/acre)

% N in compost

Legume cover crop:

Other ground cover:   tons/acre

**\*\*\* Potassium Application \*\*\***

Potassium fertilizer type:

Last September leaf total K level\*\*  % of dry weight \*\*if you don't know leaf K level enter 1.0

Please allow pop-ups. It take a minute to write up the result.

This program provides recommendations only and is not intended to be used as the sole source of information for making N and K fertilization decisions. Local environmental conditions can have a profound effect on fertilizer demands. The California Avocado Commission, California State University, and the University of California are not responsible for the accuracy of this model.

### Avocado N K Model Result

Location: Riverside 8/29/2012  
 Area: SouthCoast  
 2012 estimated Avocado yield: 10000 lb/ac  
 2011 estimated Avocado yield: 5000 lb/ac

#### Nitrogen Recommendation (lb/ac)

	N Requirement	Low Volume Fertigation	Multiple Split Broadcasts	Three Split Broadcasts
March - April	9.93	13.9	17.87	37.98
May - June	5.26	7.36	9.47	
July - Aug	7.01	9.81	12.62	42.33
Sep - Oct	7.72	10.81	13.9	
Nov - Feb	2.2	3.08	3.96	
March - Harvest 2013	8.26	11.56	14.87	20.65
<b>Total</b>	<b>40.36</b>	<b>56.5</b>	<b>72.65</b>	<b>100.9</b>

\*\*\*To account for field losses on N fertilizer with the fertilizer application methods the following numbers were multiplied by the N requirement:  
 1. Low volume fertigation - 1.4 x N requirement.  
 2. Multiple split broadcasts - 1.6 x N requirement.  
 3. Three split broadcasts - 1.8 x N requirement

#### Yield and N Analysis

<b>Total N required by trees</b>	55	lb/ac
<b>available external N</b>	15	lb/ac
<b>N required from fertilizer</b>	40	lb/ac
<b>Breakdown of available external N</b>		
Leaf Tissue Adjustment	0	lb/ac
Irrigation Water	0	lb/ac
Soil	15	lb/ac
Manure	0	lb/ac
Compost	0	lb/ac
Cover crop	0	lb/ac
Ground cover	0	lb/ac

#### K Recommendation

<b>Total K<sub>2</sub>O required by trees</b>	81	lb/ac
<b>available external K<sub>2</sub>O</b>	0	lb/ac
<b>K<sub>2</sub>O required from fertilizer</b>	81	lb/ac
<b>Potassium Chloride (Muriate) required:</b>	133	lb/ac
<b>Breakdown of available external K<sub>2</sub>O</b>		
Leaf Tissue Adjustment	0	lb/ac
Manure	0	lb/ac
Compost	0	lb/ac
**Soil	0	lb/ac

\*\*\*Because of the ability of some soils to fix K, the K available in the soil was not included in the above calculation. If the soil available K is known please subtract this value from the total K<sub>2</sub>O required by the trees.

#### Other Nutrients Requirement

Phosphorus	10.6	lbs/acre
P <sub>2</sub> O <sub>5</sub>	24.27	lbs/acre;
Sulfur	20.31	lbs/acre
Boron	15.89	oz/acre
Calcium	5.59	lbs/acre
Magnesium	11.27	lbs/acre
Zinc	6.18	oz/acre
Manganese	0.35	oz/acre
Iron	1.87	oz/acre
Copper	2.3	oz/acre

Field Name:  Crop Year:

Location:  Full Bloom Date:

**\*\*\* Crops Information \*\*\*** **\*\*\* Orchard Information \*\*\***

Estimate 2015 yield:  lb/acre Orchard Tree Age\*:

2014 Crop still on trees:  at 2015 Full Bloom Distance between trees:  ft

Estimate 2014 yield:  lb/acre Distance between rows:  ft

2014 Crop Harvest:  2015 Canopy diameter:  ft

**Figure 2.** Model modifications that include nitrogen requirements from this year's crop and last year's fruit.



1. Inclusion of the developing fruitlets and the maturing crop in the avocado nutrient model (Figure 2). Mature avocados can be harvested over an extended period of time. Therefore, the harvest date was also included in the model.
2. Addition of a nitrogen leaching factor into the model based on irrigation water applied (Percent acre-feet of water applied above required amount) and soil type (Table 1).

**Climate Regime.** We are evaluating an irrigation module in the program. Avocados are grown in three main areas in the state: San Diego, Ventura, and San Luis Obispo. The climate is very different between San Luis Obispo and San Diego. We developed irrigation requirements for these three main growing regions (Table 2). These irrigation requirement values were determined using the CIMIS weather station data and crop coefficients from the Waterright program <<http://www.waterright.org/states.asp?Option=Ag>>.

**Macro- and Micro-Nutrient Removal in the Crop.** The output results for a 10,000 lbs./a avocado crop are presented in Figure 1. In the soil potassium section of the Avomodel we have included common potassium fertilizers for growers to select. This model will do all the calculations converting pounds of elemental K to pounds of fertilizer. This feature should facilitate the use of this model.

Macro- and micro-nutrients removed in the avocado crop were included in the output of the model (Figure 1) Thus, growers will be able to determine nutrient removal

values and in coordination with tissue and soil analyses assess if fertilization is required. Finally the output of the model was changed to allow for it to be downloaded into Excel and saved. This enables growers to run the program, save it to Excel, and refer back to the results at some later date.

## CONCLUSIONS

The main contribution of the presented fertilization model is the application of mathematical functions in the calculation of the amounts of plant-available nutrients in avocado orchards. In the calculation of fertilization rates, the model includes factors such as crop load (current and previous year), canopy size, leaf nutrient levels, soil texture, and irrigation rate. The model is adjustable for different agro-ecological conditions and crop requirements. The field testing of the model is currently underway.

## LITERATURE CITED

- Arpaia, M. L., J. L. Meyer, G. W. Witney, G. S. Bender, D. S. Stottlemyer, P. R. Robinson. 1996. The Cashin Creek nitrogen fertilizer trial - what did we learn? California Avocado Society 1996 Yearbook, 80: 85-98.
- Lovatt, C. J. 2001. Properly timed soil-applied nitrogen fertilizer increases yield and fruit size of 'Hass' avocado. Journal of the American Society for Horticultural Science, 126(5): 555-559.

**Table 2.** Water requirement vs. tree age for the three major avocado growing areas in California.

Tree Age	Tree Age vs Water Needed (feet per acre)		
	Ventura	San Diego	San Luis Obispo
1	0.4	0.5	0.5
2	0.7	0.9	0.9
3	1	1.5	1.3
4	1.2	2.2	1.8
5	1.4	2.5	2.2
6	1.6	3.2	2.4
7+	1.6	3.6	2.8









## List of Completed FREP Research Projects

The following is a chronological list of final reports for FREP-funded research. Following the title is the name of the primary investigator and the project reference number, as well as a tag listing one of six subject areas (**Educational & Miscellaneous**, **Field Crops**, **Fruit, Nut, & Vine Crops**, **Horticulture Crops**, **Irrigation & Fertigation**, or **Vegetable Crops**). We invite you to view the full final reports by visiting the California Department of Food and Agriculture's Fertilizer Research and Education Program website at [www.cdffa.ca.gov/is/fldrs/frep.html](http://www.cdffa.ca.gov/is/fldrs/frep.html); or, you may contact the program at [frep@cdffa.ca.gov](mailto:frep@cdffa.ca.gov) or (916) 900-5022 to obtain printed copies.

Development of a Comprehensive Nutrient Management Website for the California Horticultural Industry

**Timothy K. Hartz, 08-0629 • Educational & Miscellaneous**

Evaluation Low-Residue Cover Crops to Reduce Nitrate Leaching, and Nitrogen and Phosphorous Losses from Winter Fallow Vegetable Production Fields in the Salinas Valley • **Richard Smith, 08-0628 • Vegetable Crops**

California Certified Crop Adviser FREP Educational Project  
**Dan Putnam, 08-0627 • Educational & Miscellaneous**

Western Fertilizer Handbook Turf & Ornamental Edition  
**Renee Pinel, 08-0007 • Educational & Miscellaneous**

Comparing the Efficiency of Different Foliarly-Applied Zinc Formulations on Peach and Pistachio Trees by Using <sup>68</sup>Zn Isotope • **R. Scott Johnson, 07-0669 • Fruit, Nut, & Vine Crops**

New Standard for the Effectiveness of Foliar Fertilizers  
**Carol Lovatt, 07-0667 • Educational & Miscellaneous**

Cherry Growth, Yield and Fruit Quality: Demand-Driven Optimization of Nitrogen Availability Relative to Storage Reserves and Fertilization Practices  
**Kitren Glozer, 07-0666 • Fruit, Nut, & Vine Crops**

Development of Certified Crop Adviser Specialty Certification and Continuing Education in Manure Nutrient Management  
**Stuart Pettygrove, 07-0405 • Educational & Miscellaneous**

California Certified Crop Adviser FREP Educational Project  
**Dan Putnam, 07-0352 • Educational & Miscellaneous**

Development and Implementation of Online, Accredited Continuing Education Classes on Proper Sampling and Application of Nitrogen/Crop Nutrients  
**Renee Pinel, 07-0223 • Educational & Miscellaneous**

Evaluation of Humic Substances Used in Commercial Fertilizer Formulations

**T.K. Hartz, 07-0174 • Educational & Miscellaneous**

Fertilizer Education Equals Clean Water  
**Kay Mercer, 07-0120 • Educational & Miscellaneous**

Can a Better Tool for Assessing 'Hass' Avocado Tree Nutrient Status be Developed? A Feasibility Study  
**Carol Lovatt, 07-0002 • Fruit, Nut, & Vine Crops**

Development of Practical Fertility Monitoring Tools for Drip-Irrigated Vegetable Production  
**Timothy K. Hartz, 06-0626 • Vegetable Crops**

Updating Our Knowledge and Planning for Future Research, Education and Outreach Activities to Optimize the Management of Nutrition in Almond and Pistachio Production • **Patrick Brown, 06-0625 • Fruit, Nut, & Vine Crops**

Development of a Model System for Testing Foliar Fertilizers, Adjuvants and Growth Stimulants  
**Patrick Brown, 06-0624 • Educational & Miscellaneous**

Site-specific Fertilizer Application in Orchards, Nurseries and Landscapes  
**Michael Delwiche, 06-0600 • Irrigation & Fertigation**

Improving Water-Run Nitrogen Fertilizer Practices in Furrow and Border Check -Irrigated Field Crops  
**Stuart Pettygrove, 04-0747 • Irrigation & Fertigation**

Fertility Management in Rice  
**Chris Van Kessel, 04-0704 • Field Crops**

Detecting and Correcting Calcium Limitations  
**Timothy K. Hartz, 04-0701 • Vegetable Crops**



Potassium Fertility Management for Optimum Tomato Yield and Fruit Color • **Tim Hartz, 03-0661** • **Vegetable Crops**

Precision Fertigation in Orchards: Development of a Spatially Variable Microsprinkler System  
**Michael Delwiche et al., 03-0655** • **Irrigation & Fertigation**

Increasing Yield of the 'Hass' Avocado by Adding P and K to Properly Timed Soil N Applications  
**Carol J. Lovatt, 03-0653** • **Fruit, Nut, & Vine Crops**

Improving the Procedure for Nutrient Sampling in Stone Fruit Trees  
**R. Scott Johnson, 03-0652** • **Fruit, Nut, & Vine Crops**

Reevaluating Tissue Analysis as a Management Tool for Lettuce and Cauliflower  
**Timothy K. Hartz, 03-0650** • **Vegetable Crops**

Environmental Compliance and Best Management Practice Education for Fertilizer Distributors  
**Renee Pinel, 03-0005** • **Educational & Miscellaneous**

Evaluation of Polyacrylamide (Pam) for Reducing Sediment and Nutrient Concentration in Tailwater from Central Coast Vegetable Fields • **Michael Cahn, 02-0781** • **Vegetable Crops**

California Certified Crop Advisor  
**Crum/Stark, 02-0331** • **Educational & Miscellaneous**

California State Fair Farm Upgrade Project  
**Michael Bradley, Joe Brengle, & Teresa Winovitch, 01-0640** • **Educational & Miscellaneous**

Crop Nitrate Availability and Nitrate Leaching under Micro-Irrigation for Different Fertigation Strategies • **Blaine Hanson & Jan W. Hopmans, 01-0545** • **Irrigation & Fertigation**

Leaf Color Chart for California Rice  
**Randal Mutters, 01-0510** • **Field Crops**

Efficient Phosphorus Management in Coastal Vegetable Production • **Timothy K. Hartz, 01-0509** • **Vegetable Crops**

Development of BMPs for Fertilizing Lawns to Optimize Plant Performance and Nitrogen Uptake While Reducing the Potential for Nitrate Leaching  
**Robert Green et al., 01-0508** • **Educational & Miscellaneous**

Site-Specific Fertilizer Application in Cotton  
**Richard Plant, 01-0507** • **Field Crops**

Effects of Cover Cropping and Conservation Tillage on Sediment and Nutrient Losses to Runoff in Conventional and Alternative Farming Systems  
**William R. Horwath et al., 01-0473** • **Field Crops**

Fertilization Technologies for Conservation Tillage Production Systems in California  
**Jeffrey Mitchell, 01-0123** • **Field Crops**

Long Term Rice Straw Incorporation: Does It Impact Maximum Yield?  
**Chris Van Kessel & William Horwath, 00-0651** • **Field Crops**

Field Evaluations and Refinement of New Nitrogen Management Guidelines for Upland Cotton: Plant Mapping, Soil and Plant Tissue Tests  
**Robert Hutmacher, 00-0604** • **Field Crops**

California Certified Crop Advisor Management Project  
**Hank Giclas, 00-0516** • **Educational & Miscellaneous**

Ammonia Emission from Nitrogen Fertilizer Application  
**Charles Krauter, 00-0515** • **Irrigation & Fertigation**

Reducing Fertilizer Needs of Potato with New Varieties and New Clonal Strains of Existing Varieties  
**Ronald Voss, 00-0514** • **Vegetable Crops**

Nitrogen Run-off in Woody Ornamentals  
**Donald J. Merhaut, 00-0509** • **Horticulture Crops**

Location of Potassium-Fixing Soils in the San Joaquin Valley and a New, Practical Soil K Test Procedure  
**Stuart Pettygrove, 00-0508** • **Field Crops**

Effect of Different Rates of N and K on Drip-Irrigated Beauregard Sweet Potatoes  
**Bill Weir, 00-0507** • **Vegetable Crops**

Evaluation of Controlled-Release Fertilizers for Cool Season Vegetable Production in the Salinas Valley  
**Richard Smith, 00-0506** • **Vegetable Crops**

Precision Horticulture: Technology Development and Research and Management Applications  
**Patrick Brown, 00-0497** • **Horticulture Crops**

From the Ground Up: A Step-By-Step Guide to Growing a School Garden  
**Jennifer Lombardi, 00-0072** • **Educational & Miscellaneous**

On-Farm Monitoring and Management Practice Tracking for Central Coast Watershed Working Groups  
**Kelly Huff, 00-0071** • **Educational & Miscellaneous**

Teach the Teachers: Garden-Based Education about Fertility and Fertilizers  
**Peggy S. McLaughlin, 00-0070** • **Educational & Miscellaneous**

Nitrogen Budgeting Workshops  
**Jim Tischer, 99-0757** • **Educational & Miscellaneous**

Evaluating and Demonstrating the Effectiveness of In-Field Nitrate Testing in Drip- and Sprinkler-Irrigated Vegetables  
**Marc Buchanan, 99-0756 • Vegetable Crops**

Demonstration of Pre-Sidedress Soil Nitrate Testing as a Nitrogen Management Tool  
**Timothy K. Hartz, 98-0513 • Vegetable Crops**

Efficient Irrigation for Reduced Non-Point Source Pollution from Low Desert Vegetables • **Charles Sanchez, Dawit Zerrihun, & Khaled Ball, 98-0423 • Vegetable Crops**

Winter Cover Crops Before Late-Season Processing Tomatoes for Soil Quality and Production Benefits  
**Gene Miyao & Paul Robins, 97-0365 M99-11 • Vegetable Crops**

Nitrogen Mineralization Rate of Biosolids and Biosolids Compost • **Tim Hartz, 97-0365 M99-10 • Educational & Miscellaneous**

Precision Agriculture in California: Developing Analytical Methods to Assess Underlying Cause and Effect within Field Yield Variability  
**Chris Van Kessel, 97-0365 M99-08 • Field Crops**

Development of an Educational Handbook on Fertigation for Grape Growers • **Glenn T. McGourty, 97-0365 M99-07 • Educational & Miscellaneous**

Relationship between Fertilization and Pistachio Diseases  
**Themis J. Michailides, 97-0365 M99-06 • Fruit, Nut, & Vine Crops**

The Effect of Nutrient Deficiencies on Stone Fruit Production and Quality - Part II  
**Scott Johnson, 97-0365 M99-05 • Fruit, Nut, & Vine Crops**

Nitrogen Fertilization and Grain Protein Content in California Wheat • **Lee Jackson, 97-0365 M99-04 • Field Crops**

Development of Fertilization and Irrigation Practices for Commercial Nurseries  
**Richard Evans, 97-0365 M99-03 • Horticulture Crops**

Irrigation and Nutrient Management Conference and Trade Fair • **Sonya Varea Hammond, 97-0365 M99-02 • Educational & Miscellaneous**

Agricultural Baseline Monitoring and BMP Implementation: Steps Towards Meeting TMDL Compliance Deadlines within the Newport Bay/San Diego Creek Watershed • **Laosheg Wu & John Kabashima, 97-0365 M99-01 • Irrigation & Fertigation**

Interaction of Nitrogen Fertility Practices and Cotton Aphid Population Dynamics in California Cotton • **Larry Godfrey & Robert Hutmacher, 97-0365 M98-04 • Field Crops**

Potassium Responses in California Rice Fields as Affected by Straw Management Practices  
**Chris Van Kessel, 97-0365 M98-03 • Field Crops**

Development and Demonstration of Nitrogen Best Management Practices for Sweet Corn in the Low Desert  
**Jose Aguiar, 97-0365 M98-02 • Field Crops**

Development of Nitrogen Best Management Practices for the "Hass" Avocado  
**Carol Lovatt, 97-0365 M98-01 • Fruit, Nut, & Vine Crops**

Nitrogen Budget in California Cotton Cropping Systems  
**William Rains, Robert Travis, & Robert Hutmacher, 97-0365 M97-09 • Field Crops**

Uniformity of Chemigation in Micro-irrigated Permanent Crops • **Larry Schwankl & Terry Prichard, 97-0365 M97-08B • Irrigation & Fertigation**

Development of Irrigation and Nitrogen-Fertilization Programs for Turfgrass  
**Robert Green, 97-0365 M97-07 • Field Crops**

Development of Irrigation and Nitrogen Fertilization Programs on Tall Fescue to Facilitate Irrigation Water Savings and Fertilizer-Use Efficiency • **Robert Green & Victor Gibeault, 97-0365 M97-07 • Irrigation & Fertigation**

Development and Testing of Application Systems for Precision Variable Rate Fertilization  
**Ken Giles, 97-0365 M97-06A • Field Crops**

Site-Specific Farming Information Systems in a Tomato-Based Rotation in the Sacramento Valley  
**Stuart Pettygrove, 97-0365 M97-05 2002 • Vegetable Crops**

Long-Term Nitrate Leaching Below the Root Zone in California Tree Fruit Orchards  
**Thomas Harter, 97-0365 M97-04 • Fruit, Nut, & Vine Crops**

Soil Testing to Optimize Nitrogen Management for Processing Tomatoes • **Jeffrey Mitchell, Don May, & Henry Krusekopf, 97-0365 M97-03 • Vegetable Crops**

Drip Irrigation and Fertigation Scheduling for Celery Production  
**Timothy K. Hartz, 97-0365 M97-02 • Vegetable Crops**

Agriculture and Fertilizer Education for K-12  
**Pamela Emery & Richard Engel, 97-0365 • Educational & Miscellaneous**

Integrating Agriculture and Fertilizer Education into California's Science Framework Curriculum • **Mark Linder & Pamela Emery, 97-0361 • Educational & Miscellaneous**

Water and Fertilizer Management for Garlic: Productivity, Nutrient and Water Use Efficiency and Postharvest Quality  
**Marita Cantwell, Ron Voss, & Blaine Hansen, 97-0207 • Vegetable Crops**

Improving the Fertilization Practices of Southeast Asians in Fresno and Tulare Counties • **Richard Molinar & Manuel Jimenez, 96-0405 • Educational & Miscellaneous**

Management of Nitrogen Fertilization in Sudangrass for Optimum Production, Forage Quality and Environmental Protection • **Dan Putnam, 96-0400 • Field Crops**

Fertilizer Use Efficiency and Influence of Rootstocks on Uptake and Nutrient Accumulation in Winegrapes  
**Larry Williams, 96-0399 • Fruit, Nut, & Vine Crops**

Survey of Changes in Irrigation Methods and Fertilizer Management Practices in California  
**John Letey, Jr., 96-0371 • Educational & Miscellaneous**

On-Farm Demonstration and Education to Improve Fertilizer Management • **Danyal Kasapligil, Eric Overeem, & Dale Handley, 96-0312 • Vegetable Crops**

Development and Promotion of Nitrogen Quick Tests for Determining Nitrogen Fertilizer Needs of Vegetables  
**Kurt Schulbach & Richard Smith, 95-0582 • Vegetable Crops**

Western States Agricultural Laboratory Proficiency Testing Program • **Janice Kotuby-Amacher & Robert O Miller, 95-0568 • Educational & Miscellaneous**

Avocado Growers Can Reduce Soil Nitrate Groundwater Pollution and Increase Yield and Profit  
**Carol Lovatt, 95-0525 • Fruit, Nut, & Vine Crops**

Determining Nitrogen Best Management Practices for Broccoli Production in the San Joaquin Valley • **Michelle Lestrangle, Jeffrey Mitchell, & Louise Jackson, 95-0520 • Vegetable Crops**

Effects of Irrigation Non-Uniformity on Nitrogen and Water Use Efficiencies in Shallow-Rooted Vegetable Cropping Systems • **Blake Sanden, Jeffrey Mitchell, & Laosheng Wu, 95-0519 • Vegetable Crops**

Developing Site-Specific Farming Information for Cropping Systems in California  
**G. Stuart Pettygrove, et.al., 95-0518 • Field Crops**

Relationship Between Nitrogen Fertilization and Bacterial Canker Disease in French Prune  
**Steven Southwick, Bruce Kirkpatrick, & Becky Westerdahl, 95-0478 • Fruit, Nut, & Vine Crops**

Practical Irrigation Management and Equipment Maintenance Workshops • **Danyal Kasapligil, Charles Burt, & Eric Zilbert, 95-0419 • Educational & Miscellaneous**

Evaluation of Controlled Release Fertilizers and Fertigation in Strawberries and Vegetables  
**Warren Bendixen, 95-0418 • Vegetable Crops**

Diagnostic Tools for Efficient Nitrogen Management of Vegetables Produced in the Low Desert  
**Charles Sanchez, 95-0222 • Vegetable Crops**

Using High Rates of Foliar Urea to Replace Soil-Applied Fertilizers in Early Maturing Peaches • **R. Scott Johnson & Richard Rosecrance, 95-0214 • Fruit, Nut, & Vine Crops**

Education through Radio  
**Patrick Cavanaugh, 94-0517 • Educational & Miscellaneous**

Effects of Four Levels of Applied Nitrogen on Three Fungal Diseases of Almond Trees  
**Beth Teviotdale, 94-0513 • Fruit, Nut, & Vine Crops**

Use of Ion Exchange Resin Bags to Monitor Soil Nitrate in Tomato Cropping Systems  
**Robert Miller, 94-0512 • Vegetable Crops**

Effects of Various Phosphorus Placements on No-Till Barley Production • **Michael J. Smith, 94-0450 • Field Crops**

Nitrogen Management through Intensive on-Farm Monitoring • **Timothy K. Hartz, 94-0362 • Vegetable Crops**

Establishing Updated Guidelines for Cotton Nutrition  
**Bill Weir & Robert Travis, 94-0193 • Field Crops**

Development of Nitrogen Fertilizer Recommendation Model for California Almond Orchards • **Patrick Brown & Steven A. Weinbaum, 93-0613 • Fruit, Nut, & Vine Crops**

Extending Information on Fertilizer Best Management Practices and Recent Research Findings for Crops in Tulare County • **Carol Frate, 93-0570 • Educational & Miscellaneous**

Nitrogen Efficiency in Drip-Irrigated Almonds  
**Robert J. Zasoski, 93-0551 • Fruit, Nut, and Vine Crops**

Citrus Growers Can Reduce Nitrate Groundwater Pollution and Increase Profits by Using Foliar Urea Fertilization  
**Carol J. Lovatt, 93-0530 • Fruit, Nut, and Vine Crops**

Educating California's Small and Ethnic Minority Farmers: Ways to Improve Fertilizer Use Efficiency through the Use of Best Management Practices (BMPs)  
**Ronald Voss, 1993 • Educational and Miscellaneous**

Development of Diagnostic Measures of Tree Nitrogen Status to Optimize Nitrogen Fertilizer Use

**Patrick Brown, 92-0668 • Fruit, Nut, & Vine Crops**

Impact of Microbial Processes on Crop Use of Fertilizers from Organic and Mineral Sources

**Kate M. Scow, 92-0639 • Field Crops**

Potential Nitrate Movement Below the Root Zone in Drip-Irrigated Almonds

**Roland D. Meyer, 92-0631 • Fruit, Nut, & Vine Crops**

Optimizing Drip Irrigation Management for Improved Water and Nitrogen Use Efficiency

**Timothy K. Hartz, 92-0629 • Vegetable Crops**

The Use of Composts to Increase Nutrient Utilization Efficiency in Agricultural Systems and Reduce Pollution from Agricultural Activities

**Mark Van Horn, 92-0628 • Educational & Miscellaneous**

Crop Management for Efficient Potassium Use and Optimum Winegrape Quality

**Mark A. Matthews, 92-0627 • Fruit, Nut, & Vine Crops**

Determination of Soil Nitrogen Content In-Situ

**Shrini K. Updhyaya, 92-0575 • Educational & Miscellaneous**

Influence of Irrigation Management on Nitrogen Use Efficiency, Nitrate Movement, and Groundwater Quality in a Peach Orchard

**R. Scott Johnson, 91-0646 • Fruit, Nut, & Vine Crops**

Improvement of Nitrogen Management in Vegetable Cropping Systems in the Salinas Valley and Adjacent Areas

**Stuart Pettygrove, 91-0645 • Vegetable Crops**

Field Evaluation of Water and Nitrate Flux through the Root Zone in a Drip/Trickle-Irrigated Vineyard

**Donald W. Grimes, 91-0556 • Fruit, Nut, & Vine Crops**

Nitrogen Management for Improved Wheat Yields, Grain Protein and the Reduction of Excess Nitrogen

**Bonnie Fernandez, 91-0485 • Educational & Miscellaneous**